

Retford Transport Assessment

Bassetlaw District Council
May 2022

Prepared on Behalf of Tetra Tech Limited. Registered in England number: 01959704

REPORT CONTROL

Project: Retford Transport Assessment
Client: Bassetlaw District Council
Job Number: B023665
File Origin: N:\Projects\B023665 - Ordsall, Retford\09 - Reports\Transport Assessment\01 - Text\B023665 Ordsall Retford Transport Assessment 31st May 2022.docx

Document Checking:

Primary Author	Rob Holland	Initialed:	RJH
----------------	-------------	------------	-----

Contributor	-	Initialed:	-
-------------	---	------------	---

Review By	Alistair Gregory	Initialed:	ASG
-----------	------------------	------------	-----

Issue	Date	Status	Checked for Issue
1	31/05/2022	Final	ASG
2			
3			
4			
5			

Contents

1	INTRODUCTION	5
2	PLANNING POLICY AND GUIDANCE	8
3	EXISTING CONDITIONS	13
4	DEVELOPMENT ASSUMPTIONS	24
5	OPPORTUNITIES TO IMPROVE SUSTAINABLE TRANSPORT INFRASTRUCTURE.....	26
6	FUTURE TRAFFIC FLOWS.....	28
7	TRIP GENERATION	31
8	TRIP DISTRIBUTION.....	35
9	HIGHWAY IMPACTS	38
10	JUNCTION CAPACITY ASSESSMENTS	45
11	MITIGATION.....	57
12	SUMMARY	76

Tables

Table 1 - Summary of Distances to Nearby Local Amenities	13
Table 2 - Distance to Nearby Towns and Cities	13
Table 3 - Summary of Bus Services Stopping near the Site	16
Table 4 - Summary of Bus Services Departing from Retford Bus Station.....	17
Table 5 - Time of the first and last Weekday trains at Retford Train Station.....	18
Table 6 – Personal Injury Collision Data January 2015 to September 2020.....	22
Table 7 - Residential Trip Rates by Mode (Houses Privately Owned)	31
Table 8 - Residential Trip Rates by Mode (Houses Privately Owned)	31
Table 9 - Residential Trip Generation by Mode (allocation HS13 – 930 Dwellings)	32
Table 10 - Residential Trip Generation by Mode (Allocation HS7 - 244 Dwellings).....	32
Table 11 - Residential Trip Generation by Mode (Allocation HS8 - 5 Dwellings).....	33
Table 12 - Residential Trip Generation by Mode (Allocation HS9 - 46 Dwellings).....	33
Table 13 - Residential Trip Generation by Mode (Allocation HS10 - 20 Dwellings).....	33
Table 14 - Residential Trip Generation by Mode (Allocation HS11 - 61 Dwellings).....	34
Table 15 - Residential Trip Generation by Mode (Allocation HS12 - 5 Dwellings).....	34
Table 16 - Distance and Journey Time to Markham Moor Junction.....	36
Table 17 - Distance and Journey Time to Worksop (A57/B6040 Roundabout)	36
Table 18 - Two-Way Ordsall South Development Traffic Impacts on Links (PCUs).....	38
Table 19 - Two-Way Ordsall South Development Traffic Impacts at Junctions (PCUs)	39
Table 20 – Ordsall South Development Flows using a New Link	44
Table 21 - Capacity Assessment Results (Ordsall South Assessed With 930 Dwellings).....	47

Table 22 - Capacity Assessment Results (Ordsall South Assessed With 1,250 Dwellings).....	52
Table 23 – Capacity Assessment Results for Entry Widening Mitigation Scheme	63
Table 24 – Capacity Assessment Results for a Signal Controlled Mitigation Scheme	64
Table 25 – Capacity Assessment Results for a Signal Controlled Mitigation Scheme	65
Table 26 – Capacity Assessment Results for a Signal Controlled Mitigation Scheme	67
Table 27 – Capacity Assessment Results for a Signal Controlled Mitigation Scheme	70
Table 28 – Capacity Assessment Results for a Signal Controlled Mitigation Scheme	72
Table 29 – Trip increases where Demand Management Mitigation Measures are Identified	73
Table 30 – Summary of Sustainable Modes Mitigation	74
Table 31 – Summary of Off-Site Highway Infrastructure Costs	74

Figures

- Figure 1 – Retford Allocation Locations
- Figure 2 – Ordsall South Site Location
- Figure 3 – Retford Traffic Data Locations
- Figure 4 – Study Area Traffic Data Locations
- Figure 5 - 2km and 5km Catchment Plan
- Figure 6 – Personal Injury Collision Data

Appendices

- Appendix A - Site Boundary
- Appendix B – TA Scoping Correspondence
- Appendix C – Traffic Data
- Appendix D – Collision Data
- Appendix E – Concept Access Layout
- Appendix F – TEMPpro Outputs
- Appendix G – Committed Development Flows
- Appendix H – Development Flows for Other Allocations
- Appendix I – Trip Generation & Distribution
- Appendix J – Traffic Calculations
- Appendix K – Capacity Assessments
- Appendix L – Mitigation

1 INTRODUCTION

1.1 BACKGROUND

1.1.1 Tetra Tech has been appointed by Bassetlaw District Council (BDC) to prepare a Transport Assessment document (TA) to assess the impact of housing growth identified in the latest version of the Draft Local Plan for Bassetlaw which was published for consultation in November 2020. The following sites are considered in this report as shown in **Figure 1**:

- HS7 Trinity Farm, Retford – 244 dwellings
- HS8 Milnercroft, Retford – 5 dwellings
- HS9 Former Elizabethan School, Retford – 46 dwellings
- HS10 St. Michael's View, Hallcroft Road, Retford – 20 dwellings
- HS11 Fairy Grove, Grove Road, Retford – 61 dwellings
- HS12 Station Road, Retford – 5 dwellings
- HS13 Ordsall, Retford – 930 dwellings (note that an additional 320 dwellings are assessed as part of a sensitivity test)

1.1.2 As indicated above, Site HS13 is the largest of the seven sites and therefore forms the focus of this report. It should be noted that the draft allocation is for approximately 890 dwellings. Nevertheless, as advised by BDC this report assesses a development of 930 dwellings plus a sensitivity test with an additional 320 dwellings (a total of 1,250 dwellings) to understand the potential for the site to accommodate more growth than the minimum.

1.1.3 The location of Site HS13 is shown in **Figure 2** and the site boundary is included in **Appendix A**. Trip generation from all the above sites has been considered in this report. In addition, trip generation from the Apleyhead and Peaks Hill Farm major allocations have also been included.

1.1.4 The findings of this report will be used to help inform BDC on transport and highway matters relating to Local Plan growth.

1.1.5 The highway network near the site is maintained by Nottinghamshire County Council (NCC) in their capacity as the local highway authority. The A1(T) is maintained by National Highways. BDC is the local planning authority.

1.2 SCOPE OF TRANSPORT ASSESSMENT

1.2.1 This TA has been prepared in accordance with the Ministry of Housing, Communities and Local Government (MHCLG) Planning Practice Guidance 'Travel Plans, Transport Assessments and Statements' (2014), which presents the Government's most up-to-date guidance on the preparation of highways and transportation documents to support development proposals. It has also been prepared in accordance with the National Planning Policy Framework (NPPF).

- 1.2.2 Preliminary discussions were held with NCC highways in relation to the scope of this report and correspondence is included in **Appendix B**. NCC specifically advised in relation to committed developments and the TA study area and have provided detailed comments on earlier drafts of this report which have been addressed in this version following further discussion. NCC also indicated that Main Road between Ollerton Road and the A638 through the village of Eaton is not well suited to a material increase in traffic due to its existing characteristics.

1.3 TA STUDY AREA

- 1.3.1 The TA study area has been informed by discussions with NCC and comprises of the following off-site junctions as shown in **Figures 3 and 4**:

- A1/A620 Retford Road/B6079 Retford Road
- A1/B6420 Mansfield Road/A614 Blyth Road/A57
- A1/Elkesley Bridge Road/Jockey Lane/Eskil Way
- A1/B6387 Dover Bottom
- A1 Markham Moor Junction
- A620 Babworth Road/B6420 Mansfield Road/A620 Straight Mile/Sutton Lane
- A620 Babworth Road/Ordsall Road
- A620 Amcott Way/Bridlegate/A620 Hospital Road/A638 North Road/Hallcroft Road
- A620 Amcott Way/A620 Moorgate/A638 Arlington Way
- A638 Arlington Way/Spital Hill/Chapelgate
- A638 Arlington Way/Grove Street
- A638 Arlington Way/A638 London Road/Carolgate
- Ollerton Road/West Hill Road
- A638 London Road/Whitehouses Road
- A638 London Road / Whinney Moor Lane / Bracken Lane
- All Hollows Street / High Street / Goosemoor Lane
- Ollerton Road / Main Road
- A638 / Main Road (Eaton)
- A638 / B6387 Rectory Lane

1.4 REPORT LAYOUT

- 1.4.1 This TA investigates the highways and transportation issues associated with development of the site. The structure of the report is as follows:

- Chapter 2 summarises relevant planning policy documents.
- Chapter 3 describes existing conditions.
- Chapter 4 outlines development assumptions.
- Chapter 5 explores the opportunities for encouraging sustainable travel.

- Chapter 6 outlines the future assessment year, background traffic growth and committed development traffic.
- Chapter 7 calculates development trip generation.
- Chapter 8 distributes development trips.
- Chapter 9 presents highway impacts.
- Chapter 10 presents the results of capacity assessments.
- Chapter 11 considers the need for mitigation.
- Chapter 12 summarises the report.

2 PLANNING POLICY AND GUIDANCE

2.1 INTRODUCTION

2.1.1 The following planning policy and guidance documents have been considered in the preparation of this TA:

- National Planning Policy Framework (Ministry of Housing Communities and Local Government (MHCLG), July 2021)
- Draft Bassetlaw Local Plan (BDC, November 2020)
- Draft Bassetlaw Local Plan Publication Version Addendum (BDC, January 2022)
- Draft Bassetlaw Local Plan Publication Version Second Addendum (BDC, May 2022)
- Bassetlaw District Local Development Framework – Core Strategy and Development Management Policies DPD (BDC, 2011)
- Nottinghamshire Local Transport Plan (LTP) 2011 - 2026 (NCC, 2011)
- Nottinghamshire Highway Design Guide (NCC, 2021)
- Travel Plans, Transport Assessments and Statements (MHCLG, 2014)

2.2 NATIONAL PLANNING POLICY FRAMEWORK

The NPPF sets out the Government’s planning policies for England and how these should be applied. An updated version of the NPPF was published in July 2021. At the heart of the NPPF is a presumption in favour of sustainable development. In terms of transport, Paragraph 110 states that:

“In assessing sites that may be allocated for development in plans, or specific applications for development, it should be ensured that:

- a) appropriate opportunities to promote sustainable transport modes can be – or have been – taken up, given the type of development and its location.*
- b) safe and suitable access to the site can be achieved for all users;*
- c) the design of streets, parking areas, other transport elements and the content of associated standards reflects current national guidance, including the National Design Guide and the National Model Design Code; and*
- d) any significant impacts from the development on the transport network (in terms of capacity and congestion), or on highway safety, can be cost effectively mitigated to an acceptable degree.”*

2.2.1 Paragraph 111 goes on to state that “Development should only be prevented or refused on highways grounds if there would be an unacceptable impact on highway safety, or the residual cumulative impacts on the road network would be severe.”

2.2.2 To address this, applications for development should give priority to pedestrian, cycle and public transport movements; address the needs of people with disabilities and reduced mobility; create places that are safe, secure and attractive; allow for the efficient delivery of goods, service and emergency vehicles; and be designed to enable charging of plug-in vehicles.

2.2.3 Considering the above, this TA considers whether the development proposals will provide suitable access for all travel modes, as well as whether any associated increase in traffic will result in a severe cumulative impact.

2.3 DRAFT BASSETLAW LOCAL PLAN

2.3.1 The latest version of the Draft Local Plan for Bassetlaw was published for consultation in November 2020. In addition, a Publication Version Addendum was prepared in January 2022 and a Publication Version Second Addendum was prepared in May 2022. Policy ST27, Site HS13 covers the land at Ordsall South, which is the subject of this study. For completeness, trip generation from the six other Local Plan sites in Retford is also considered in this report, namely:

- HS7 Trinity Farm, Retford – 244 dwellings
- HS8 Milnercroft, Retford – 5 dwellings
- HS9 Former Elizabethan School, Retford – 46 dwellings
- HS10 St. Michael's View, Hallcroft Road, Retford – 20 dwellings
- HS11 Fairy Grove, Grove Road, Retford – 61 dwellings
- HS12 Station Road, Retford – 5 dwellings

2.3.2 Land at Ordsall South is identified for development for residential, community and open space uses to deliver a safe, sustainable, quality living environment. The Bassetlaw Local Plan 2022-2038 Publication Version Second Addendum identifies that development should deliver approximately 890 dwellings during the Plan period to 2038 and should incorporate a mix of housing types, sizes, and tenures to meet local needs. With regards to transport and connectivity, Policy ST27 states the following for site HS13:

“all necessary transport infrastructure improvements through direct mitigation or contributions to new and improved infrastructure, referring to the development's Transport Assessment and Travel Plan, informed by Local Highway Authority advice, detailing:

- I. A two-point distributor standard access to the east and west parts of the site from Ollerton Road for vehicles, cyclists and pedestrians;*
- II. A well-connected street hierarchy that provides high quality, safe and direct walking, cycling and public transport routes within the site and to neighbouring areas by non vehicular modes of transport;*
- III. Appropriate improvements to off-site highway infrastructure as identified by the Infrastructure Delivery Plan in the locality of the site including towards:*
 - The junction at the A620 Babworth Road / B6420 Mansfield Road / A620 Straight Mile / Sutton Lane;*
 - The junction at Ordsall Road / A620 Babworth Road*
 - The junction at London Road / Whitehouses Road*
 - Junctions at the: A614 Blythe Road / A57 / A1; the A60 Mansfield Road / A619; the A57 / Sandy Lane; the A57 / Claylands Avenue / Shireoaks Common; the A57 /*

B6034 / Netherton Road and the A57 / B6040; and the A57 / A614 / A1 Five Lanes End roundabout

- *The provision of off-site traffic calming / management schemes along Main Road, Eaton and Ordsall Old Village.*
- IV. *Appropriate highway demand management measures to be in operation throughout the lifetime of the construction of the site;*
- V. *New and improved pedestrian and cycle links from the site to neighbouring areas including to Old Ordsall Village;*
- VI. *A new footpath and marked cycle path along the Ollerton Road frontage (east and west) to connect to the existing network at Ordsall;*
- VII. *Improvements to the existing Public Rights of Way that cross the site and run along its boundaries;*
- VIII. *A financial contribution towards a high frequency bus service from the site to Retford town centre and the wider area supported by appropriate public transport infrastructure within the site.*

Infrastructure shall be secured by planning condition, agreement and/or other mechanism considered appropriate by the relevant infrastructure partners, the Council and the developer.”

2.4 BASSETLAW DISTRICT LOCAL DEVELOPMENT FRAMEWORK – CORE STRATEGY & DEVELOPMENT MANAGEMENT POLICIES DPD 2011-2028

2.4.1 Adopted by Bassetlaw District Council on 22 December 2011, the Core Strategy identifies the overarching framework for new development over an 18-year period and sets out a vision for change in Bassetlaw up to 2028.

2.4.2 Within the Vision for Bassetlaw, the Core Strategy states that future development proposals in Retford for the period up to 2028:

“will continue to provide an attractive range of homes and a good concentration of services and facilities, allowing it to maintain its role in supporting surrounding rural communities without compromising its market town character. Development in Retford will, therefore, protect the town’s retail and service role, delivering growth of a scale that respects the town’s heritage assets and, where appropriate, supporting the increased value of the Chesterfield Canal”.

2.4.3 A set of 10 Strategic Objectives are, as such set out as part of the Core Strategy. Of these 10 Objectives, the following are most applicable to future development within the Retford area:

- **SO1** – To provide a range of high-quality market and affordable houses in Worksop, Retford, Harworth Bircotes, Carlton-in-Lindrick/Langold, Tuxford, Misterton and sustainable rural settlements (as identified in the Settlement Hierarchy) to meet the diverse needs of Bassetlaw’s growing population.
- **SO4** – To enhance and protect the vitality and viability of the centres of Worksop, Retford, Harworth Bircotes and Tuxford, through environmental improvements and provision of increased town centre retail, employment and leisure development.
- **SO6** – To ensure that all new development addresses the causes and effects of climate change by, as appropriate, reducing or mitigating flood risk; realising opportunities to utilise

renewable and low carbon energy sources and/or infrastructure, alongside sustainable design and construction; taking opportunities to achieve sustainable transport solutions; and making use of Sustainable Drainage Systems.

- **SO7** – To ensure that all new development enhances the attractiveness and local distinctiveness of the area and, where appropriate, achieves its full potential against national and local design standards.
- **SO10** – To ensure the provision of the essential physical, social and green infrastructure required to support the District's growth.

2.4.4 This TA explores whether development of the site will positively contribute towards the vision and applicable Strategic Objectives set by BDC.

2.5 NOTTINGHAMSHIRE LOCAL TRANSPORT PLAN (LTP3) 2011-2026

2.5.1 The Nottinghamshire Local Transport Plan (LTP3) 2011-2026 was published in 2011. Replacing the second Local Transport Plan for Greater Nottingham, the LTP3 details the transport strategy for the whole of the county of Nottinghamshire for the period between April 2011 and March 2026.

2.5.2 Underpinned by 12 local transport objectives which identify how transport in Nottinghamshire will help support economic growth; protect the environment; improve health and safety; improve accessibility, and maintain and improve existing infrastructure, three transport goals are set out within the LTP3. These Transport Goals are to:

- Provide a reliable, resilient transport system which supports a thriving economy and growth whilst encouraging sustainable and healthy travel.
- Improve access to key services, particularly enabling employment and training opportunities.
- Minimise the impacts of transport on people's lives, maximise opportunities to improve the environment and help tackle carbon emissions.

2.5.3 This TA considers how development of the site accords with the aims and policies of the Nottinghamshire Local Transport Plan as it is in an area easily accessible by sustainable modes of transport.

2.6 NOTTINGHAMSHIRE HIGHWAY DESIGN GUIDE

2.6.1 The Nottinghamshire Highway Design Guide provides clear and common guidance to developers across Nottinghamshire with reasonably practicable and agreeable guidance to assist in the delivery of housing growth, encourage sustainable development and minimise the impact of development on the highway.

2.6.2 This TA has considered the Nottinghamshire Highway Design Guide in the production of this report.

2.7 TRAVEL PLANS, TRANSPORT ASSESSMENTS AND STATEMENTS

2.7.1 The Planning Practice Guidance provides information relating to the preparation of a TA, including when they are required, the scope of the report and what information to include. This TA has been prepared in accordance with the Planning Practice Guidance and NCC Travel Plan Guidance <https://www.nottinghamshire.gov.uk/media/124515/travelplanguidance.pdf>

2.8 SUMMARY

2.8.1 Future development of the site should be in accordance with the policy objectives set out in the national and local planning policy summarised in this chapter.

3 EXISTING CONDITIONS

3.1 EXISTING SITE

3.1.1 The location of the Ordsall South site is illustrated on **Figures 1** and **2**. The site currently comprises agricultural land and is bound to the north by residential development and Retford Golf Club, and to the east, west and south by agricultural land.

3.1.2 For this TA, the site is assumed to be accessed via Ollerton Road, which bisects the site and divides the site into an eastern and western parcel. The western parcel of the site is larger than the eastern parcel.

3.2 NEARBY LOCAL FACILITIES AND AMENITIES

3.2.1 Retford town centre is approximately 4.0km from the site and provides a range of employment, retail, leisure, and other needs. **Table 1** below shows the approximate distance between the site and other key local facilities/amenities nearer to the site. The distances should be treated as approximate distances as they will vary depending on where within the site the measurement is taken from.

Table 1 - Summary of Distances to Nearby Local Amenities

Nearby Local Amenities	Approximate Distance (km)
Convenience Store	1.0
Post Office	1.0
Pre-School	1.0
Pharmacy	1.1
Primary School	1.6
Retford Train Station	1.8
Secondary School	2.6
Retford Hospital	3.5
Doctor's Surgery	3.7
Dentist	3.8

3.3 WIDER CONTEXT

3.3.1 In the wider area, **Table 2** below summarises approximate distances to the nearest large towns and cities.

Table 2 - Distance to Nearby Towns and Cities

Nearby Local Amenities	Approximate Distance (km)
Doncaster	31.4
Lincoln	35.2
Nottingham	50.0
Sheffield	48.3

3.4 PEDESTRIAN ACCESSIBILITY

Pedestrian Infrastructure

- 3.4.1 There are no footways on Ollerton Road adjacent to the site frontage. To the north of the site, footways are provided on both sides of Ollerton Road and form part of a network of pedestrian routes within Retford. To the south of the site there are no footways adjacent to Ollerton Road.
- 3.4.2 A public footpath is aligned in an east-west direction through the western parcel of the site. The footpath connects Brecks Road in the east with a bridleway beyond the western boundary of the site. Several public footpaths are aligned through the eastern parcel of the site, along Water Lane and connecting to High Street. These footpaths form part of a network of Public Rights of Way in the local area, increasing connectivity with Ordsall and the wider countryside.

Pedestrian Catchment Area

- 3.4.3 In terms of what constitutes a reasonable walking distance it is necessary to consider what is realistic for a walking trip. The Chartered Institution of Highways and Transportation (CIHT) document 'Guidelines for Providing for Journeys on Foot' (2000) states that "walking accounts for over a quarter of all journeys and four fifths of journeys less than one mile". The document also provides guidance on acceptable walking distances and suggests that a preferred maximum walking distance of 2km is applicable for commuting or school trips.
- 3.4.4 It can therefore be concluded that distances up to 2km can be considered reasonable to be undertaken on foot, and that walking is a realistic mode to consider for trips within this distance. Whilst this does not preclude pedestrians from undertaking longer journeys, it is considered that 2km is reasonable. Based on an average walking speed of 1.4 m/s it can be concluded that a 2km walk would take approximately 24 minutes.
- 3.4.5 A 2km catchment from the site is presented at **Figure 5**. The catchment demonstrates that all Ordsall and some areas of Retford are within 2km of the site. As a result, amenities such as the nearest convenience store, pharmacy, post office, pre-school and primary school are located within a reasonable walking distance to the site. **Table 1** summarises these distances.
- 3.4.6 Improvements will be required to existing pedestrian infrastructure to maximise accessibility of the site for pedestrians. Any new infrastructure should tie in with existing nearby infrastructure. Subject to infrastructure improvements, the location of the site near to local facilities/amenities may help to encourage a proportion of shorter trips from the area to be made on foot. It is considered that travel on foot should be the key mode of travel for trips originating from the site and the surrounding area. Walking should be encouraged as the most appropriate mode of travel for local trips.

3.5 CYCLIST ACCESSIBILITY

Cycle Infrastructure

- 3.5.1 Retford has the key attributes to be an attractive town to cycle around. The urban area is less than 4km from north to south and less than 3km from east to west, which coupled with the generally flat topography ensures that all major trip generators are within easy reach.
- 3.5.2 The corridors formed by the river and canal provide good opportunities to travel across the town without coming into conflict with general traffic, giving Retford significant potential to make cycling the mode of choice for all trips to access employment, education, healthcare and leisure facilities provided locally.
- 3.5.3 However, at present, the coverage and quality of infrastructure to support and encourage cyclists falls below modern standards, both in terms of on-road and off-road routes in place, including those along the canal and river. Where attractive links are provided, they are often undermined by a lack of continuity and the absence of safety features at major junctions.
- 3.5.4 In the immediate vicinity of the site, there are no formal cycle facilities along Ollerton Road meaning that cyclists must travel within the carriageway.

Cycle Catchment Area

- 3.5.5 In much the same way as pedestrian trip lengths are defined, the length of cycling trips will be governed by routes that are available and trip length, although several other factors often mitigate for or against making these trips.
- 3.5.6 Local Transport Note 1/20 'Cycle Infrastructure Design' (DfT, 2020) states that *"two out of every three personal trips are less than five miles in length – an achievable distance to cycle for most people"*. Accounting for the fact that some people will not want to cycle five miles, three miles has been assumed in this report to inform a catchment area for cycle trips. Three miles is equivalent to approximately 5km.
- 3.5.7 **Figure 5** shows a 5km catchment centred on the site. A 5km distance includes all of Retford, Ordsall, Newtown and Balk Field. Cycling should also therefore be encouraged as an appropriate mode of travel for local trips.

3.6 BUS ACCESSIBILITY

- 3.6.1 The CIHT document 'Buses in Urban Developments' (2018) recommends a maximum walking distance to bus stops of 400m. Therefore, 400m is generally regarded as being the maximum walking distance to a public transport access point.

- 3.6.2 In the first instance, it should be noted that the size of the site is such that, the distance to a bus stop will vary depending on where the measurement is taken from. The far extremities of the site are more than 1km from Ollerton Road. Future development of the site should therefore facilitate bus access into the development itself. Nevertheless, for the purpose of this Chapter, existing bus provision is considered.
- 3.6.3 The nearest bus stops to the site are shown in **Figure 1**. A southbound bus stop is located on the eastern side of Ollerton Road, approximately 100m north of the site boundary, opposite Glen Eagles Way. The bus stop comprises of a flag and pole and timetable information.
- 3.6.4 Approximately 350m north of the site boundary, bus stops are located on both sides of West Hill Road (Brecks Road stops). Both stops consist of a flag, timetable information and a shelter.
- 3.6.5 Additional bus stops are located approximately 650m from the northern site boundary on Welbeck Road and High Street. A summary of regular bus services stopping at the nearest bus stops to the site is provided in **Table 3**.

Table 3 - Summary of Bus Services Stopping near the Site

Service / Route	Bus Stop	Mon - Fri Frequency			Saturday Frequency	Sunday Frequency
		7am – 9am	9am – 5pm	4pm - 6pm	9am – 6pm	9am – 6pm
335: Retford - Ollerton	Glen Eagles Way	N/A	N/A	1 Bus	1 Bus	No Service
335: Newark – Retford	Brecks Road	1 Bus	N/A	N/A	1 Bus	No Service
Doncaster Shopper: Trafford Way at Doncaster Interchange – Tuxford	Glen Eagles Way	N/A	1 Bus	N/A	N/A	No Service
Doncaster Shopper: Tuxford – Trafford Way at Doncaster Interchange	Brecks Road	N/A	1 Bus	N/A	N/A	No Service
Sherwood Arrow: Retford - Nottingham	Glen Eagles Way	2 Buses	4 Buses	1 Bus	4 Buses	2 Buses
Sherwood Arrow: Nottingham – Retford	Brecks Road	N/A	4 Buses	1 Bus	4 Buses	2 Buses
47 Retford – Ordsall	Brecks Road	N/A	1 Bus Every Hour Between 09:15 and 14:15	1 Bus	1 Bus Every Hour Between 09:15 and 15:15, Then A Further 2 Buses	No Service
47 Ordsall – Retford	Brecks Road	N/A	1 Bus Every Hour Between 09:25 and 14:25	1 Bus	1 Bus Every Hour Between 09:25 and 15:25, Then A Further 2 Buses	No Service
Lincoln Shopper: Lincoln – Retford	Welbeck Road	N/A	1 Bus	N/A	N/A	No Service
Lincoln Shopper: Retford – Lincoln	Welbeck Road	N/A	1 Bus	N/A	N/A	No Service

3.6.6 As shown in **Table 4** there are four bus services that operate to the nearest bus stops to the site (Glen Eagles Way and Brecks Road). But only one of these (the Sherwood Arrow) offers frequent services, providing a connection between Ordsall and Retford.

3.6.7 However, whilst the other bus services are infrequent, all bus services stopping near the site also stop directly outside Retford Bus Station, located approximately 2 miles from the site boundary. The bus station is approximately an 11 minute cycle journey or a 7 minute car journey from the site. Retford Bus Station offers an additional 15 services to several key employment centres including Worksop, Doncaster, Gainsborough, Newark, and Nottingham. **Table 4** summarises the location and frequency of additional services departing from Retford Bus Station. The frequency of buses operating on a Sundays is not included in the table as none of the services operate on Sundays.

Table 4 - Summary of Bus Services Departing from Retford Bus Station

Service / Route	Monday – Friday Frequency		Saturday Frequency	
	No. of Buses Per Day	Approximate Frequency	No. of Buses Per Day	Approximate Frequency
136 Retford - Walesby	4	Approx. every two hours between 10:30 and 16:40	3	Approx. every two hours between 10:30 and 14:30
190 Retford – Tuxford	3	Approx. every 70 mins between 16:05 and 18:25	3	Approx. every 70 mins between 16:05 and 18:25
195 Retford - Gainsborough	2	06:50 and 17:10	2	06:50 and 17:10
197 Retford - Beckingham	1	12:30	1	12:30
335; Retford – Ollerton	1	17:30	1	17:30
27 Retford - Everton	6	Approx. every 2 hours between 08:45 and 15:25/15:35, then 18:15	6	Approx. every 2 hours between 08:45 and 15:35, Then 18:15
29 Retford - Doncaster	5	Approx. every 2 – 3 hours between 08:54 and 17:35	5	Approx. every 2 – 3 hours between 08:54 and 17:35
37 Retford - Newark	11	Approx. every hour between 08:00 and 18:20	11	Approx. every hour between 08:00 and 18:20
43 Retford – Worksop / Wensleydale	14	Approx. every hour between 05:45 and 19:05	14	Approx. every hour between 05:45 and 19:05
95 Retford - Gainsborough	6	Approx. every 2 hours between 08:40 and 14:30, then 16:00 and 17:50	6	Approx. every 2 hours between 08:40 and 14:30, then 16:00 and 17:50
97 Retford - Gainsborough	4	Approx. every hour between 09:30 and 15:55	4	Approx. every 2 hours between 09:30 and 15:55
99 Retford - Doncaster	10	Approx. every hour between 07:40 and 17:45	10	Approx. every hour between 07:40 and 17:45
123 Retford Town Circular Route	3	11:00, 12:00 and 13:30	3	11:00, 12:00 and 13:30

3.6.8 The information above highlights that there are regular bus services during peak travel times to some key nearby towns which offer employment, retail, leisure and other opportunities to future residents.

3.7 RAIL SERVICES

3.7.1 The nearest train station is Retford Station, which is located approximately 1.1 miles north-east of the site boundary when walking or cycling. This equates to a walk of approximately 20 minutes or a cycle ride of approximately 7 minutes. When travelling by road, the train station is located approximately 2.4 miles from the site boundary. This is a drive of approximately 7 minutes. In the context of the site, the train station is therefore more suited to pedestrian and cycle trips than car trips. However, it is worth noting that the condition of the underpass beneath the railway line between Station Road and Tunnel Road may discourage people from using this route, particularly cyclists who may struggle to negotiate the steps.

3.7.2 Many trains operate throughout the day to destinations such as London, Doncaster, York, Sheffield and Lincoln catering for peak commuter travel and as well as other journey types. **Table 5** summarises the times of the first and last weekday trains at Retford Station.

Table 5 - Time of the first and last Weekday trains at Retford Train Station

Train	Arrivals from London Kings Cross	Departures to London Kings Cross	Arrivals from Doncaster	Departures to Doncaster	Arrivals from York	Departures to York
First Train	07:33	05:51	05:50	07:34	08:32	07:56
Last Train	23:16	23:02	23:01	23:17	23:01	16:48

Train	Arrivals from Sheffield	Departures to Sheffield	Arrivals from Lincoln	Departures to Lincoln
First Train	06:23	06:13	07:19	06:24
Last Train	22:28	22:51	23:17	21:33

3.7.3 Retford Train Station is located on the East Coast Main Line between Edinburgh and London Kings Cross, calling at Newcastle, York, Doncaster, and Peterborough on the way. The Station is also located on the Sheffield to Lincoln line.

3.7.4 Trains to London Kings Cross operate every day of the week, with approximately one train every one to two hours. Trains to London have an approximate journey time of between 90 and 105 minutes. During peak journey times, there are four trains between 6am and 9am and six trains between 4pm and 7pm.

- 3.7.5 One train departs from Retford to Edinburgh during the week at 0756 hrs, taking approximately 3 hours and 25 minutes, calling at Doncaster, York, Northallerton, Darlington, Durham and Newcastle before 1000 hrs.
- 3.7.6 Two trains per hour depart from Retford to Lincoln between Monday and Friday and have an approximate duration of around 35 minutes. Trains departing from Retford to Lincoln on Saturday and Sunday typically operate at a frequency of around one train per hour.
- 3.7.7 Trains are frequently available to Doncaster, with three trains departing from Retford at peak times between 0700 and 0900 hrs, Monday to Friday. Outside of peak times, one train is available every one to two hours. On average, trains to Doncaster typically take around 15 minutes.
- 3.7.8 In addition to these regular train services, two direct trains are available to Hull during the week, and three direct trains are available to Hull during the weekends, taking approximately 1 hour and 10 minutes. One direct train is available to Beverley, taking approximately 1 hour and 40 minutes, Monday to Saturday and one direct train to Bradford, taking approximately 1 hour and 25 minutes.
- 3.7.9 Travel by train provides a genuine alternative to the private car and should therefore assist in encouraging modal shift away from the private car. The journey time to the station is similar when cycling or driving or driving by car due to the longer distance when travelling by car. Walking time to the train station is approximately 20 minutes, which should encourage walking and cycling between the site and the station. Furthermore, there are 38 sheltered bicycle parking spaces at Retford Train Station, providing the opportunity for staff and visitors to cycle to and from the station.
- 3.7.10 Additionally, bus stops located directly adjacent to the station on Victoria Road are served by the Sherwood Arrow service, which also stops at the nearest bus stops to the site boundary.
- 3.7.11 Using sustainable means of transport in this way is therefore an attractive and viable option between the site and the Train Station.

3.8 HIGHWAY NETWORK

To/from Retford Town Centre

- 3.8.1 The two most likely routes for vehicles to travel between the site and Retford town centre are via Ordsall Road/Babworth Road or Goosemoor Lane/Whitehouses Lane/London Road.
- 3.8.2 Ordsall Road, which is a continuation of Ollerton Road is a single carriageway subject to a 30mph speed limit. It is a typical distributor road with footways adjacent to both sides of the carriageway and is street lit. Babworth Road is aligned in an east to west direction and provides a route to

the A1 in the west and the town centre in the east. It joins Ordsall Road at a mini-roundabout. Babworth Road is a single carriageway subject to a 40mph speed limit in the vicinity of Ordsall Road. To the east, the speed limit changes to 30mph and to the west, the speed limit changes to 50mph. Babworth Road has a footway adjacent to one side of the carriageway and is street lit. Bus routes operate along Ordsall Road and Babworth Road.

3.8.3 Goosemoor Lane/Whitehouses Road is aligned in an east to west direction and provides a link between Ollerton Road and London Road. It is a single carriageway subject to a 30mph speed limit. Street lighting is provided. Footways are typically provided adjacent to both sides of the carriageway, although a section of Goosemoor Lane has a footway adjacent to one side only. London Road is aligned in a north to south direction and provides a route between the A1 in the south (Markham Moor) and Retford town centre in the north. Near Whitehouses Road, London Road is subject to a 40mph speed limit. To the south, the speed limit changes to 50mph and to the north, the speed limit changes to 30mph.

3.8.4 The highway network around the town centre includes several signal-controlled junctions which are known to experience congestion during peak periods.

To/from the Markham Moor Junction

3.8.5 The Markham Moor junction on the A1 is likely to be used by vehicles travelling to/from the A1 (south) and for trips to/from Lincoln via the A57. It will also facilitate local trips to villages south of Markham Moor. The Markham Moor junction is a recently improved dumbbell layout.

3.8.6 Trips from the site are likely to use London Road or Jockey Lane/A1 to access the Markham Moor junction. To access London Road, some vehicles may use Goosemoor Lane/Whitehouses Road, although it is also likely that vehicles will use Main Road through the centre of Eaton village. Main Road is a single carriageway with limited footway provision and limited street lighting. Main Road is also narrow in places with reduced visibility. Furthermore, the existing bridge over the River Idle is only wide enough for one-way vehicular traffic.

To/from the A1 (north)

3.8.7 Vehicles are likely to access the A1 at its junction with the A620 Retford Road via Ordsall Road and Babworth Road. The junction with the A1 includes slip roads which facilitate all movements.

To/from Worksop

3.8.8 There are three likely routes for vehicles travelling to/from Worksop as identified below:

- Brick Yard Lane, Jockey Lane, the A1(T), A57
- A620, B6079, A57
- B6420, A57

3.9 BACKGROUND TRAFFIC FLOWS

3.9.1 Full classified turning counts were undertaken on Wednesday 7th July 2021 between 07:30-09:30 and 16:30-18:30 at the following junctions:

- A1/A620 Retford Road/B6079 Retford Road
- A1/B6420 Mansfield Road/A614 Blyth Road/A57
- A1/Elkesley Bridge Road/Jockey Lane/Eskil Way
- A1/B6387 Dover Bottom
- A1 Markham Moor Junction
- A620 Babworth Road/B6420 Mansfield Road/A620 Straight Mile/Sutton Lane
- A620 Amcott Way/Bridlegate/A620 Hospital Road/A638 North Road/Hallcroft Road
- Ollerton Road/West Hill Road
- Ollerton Road / Main Road
- A638 / Main Road (Eaton)
- A638 / B6387 Rectory Lane

3.9.2 NCC has been monitoring traffic flows throughout the county to compare flows recorded since the Covid-19 pandemic began with flows before the Covid-19 pandemic. Traffic flows in Retford for the week commencing 5th July 2021 are below flows recorded in March 2020 before the national lockdown. As such, NCC has provided Covid-19 adjustment factors to apply to the AM and PM peak hour traffic flows recorded in the above surveys. The relevant factors are 92% (AM) and 91% (PM).

3.9.3 As agreed with NCC, existing peak period classified turning counts have been obtained for study area junctions where new counts have not been obtained. The following existing counts have been obtained and used in this TA:

- A620 Babworth Road/Ordsall Road – Tuesday 7th May 2016
- A620 Amcott Way/A620 Moorgate/A638 Arlington Way – Mon 12th March 2018
- A638 Arlington Way/Spital Hill/Chapelgate – Mon 12th March 2018
- A638 Arlington Way/Grove Street – Mon 12th March 2018
- A638 Arlington Way/A638 London Road/Carolgate – Mon 12th March 2018
- A638 London Road/Whitehouses Road – Thursday 12th May 2016
- A638 London Road / Whinney Moor Lane / Bracken Lane – Tuesday 10th October 2017

- High Street / Goosemoor Lane – Tue 4th December 2018

3.9.4 Traffic data is presented in **Appendix C**.

3.10 COLLISION ANALYSIS

3.10.1 Personal Injury Collision (PIC) data has been obtained from NCC for the most recently available five-year period between 1st January 2015 and 30th September 2020. The Study Area comprises of Ollerton Road/Ordsall Road between its junctions with the A620 Babworth Road to the north of the site and Main Road (west of Eaton) to the south of the site. The study area also includes High Street and Goosemoor Lane.

3.10.2 Collision data is presented in **Appendix C – Traffic Data**

3.10.3 Appendix **D** and **Table 6** below summarises the recorded PICs. A plot of collision locations and severity is included as **Figure 6**.

Table 6 – Personal Injury Collision Data January 2015 to September 2020

Year	Severity			Total
	Slight	Serious	Fatal	
2015	3	1	0	4
2016	1	0	0	1
2017	3	2	0	5
2018	4	1	0	5
2019	0	2	0	2
2020	1	0	1	2
Totals	12	6	1	19

3.10.4 In total, there were nineteen collisions that occurred within the study area and of these collisions, 12 were classified as slight in severity, six were classified as serious in severity and one was classified as fatal in severity. No recorded collisions involved cyclists. However, a total of four collisions involved pedestrians.

3.10.5 A total of four collisions occurred at the Babworth Road/Ordsall Road mini-roundabout junction, with three of these classified as slight in severity and one classified as serious in severity. All of these collisions involved vehicles only and involved vehicles performing conflicting movements at the mini roundabout junction.

3.10.6 A total of four collisions involving pedestrians occurred within the study area, three of which occurred along Ordsall Road and West Hill Road. Only one of these incidents involving pedestrians was classified as serious in severity and involved a car colliding with a child outside Ordsall Primary School. The remaining two collisions were classified as slight in severity, one of

which involved a car colliding with a young pedestrian after daylight hours, whilst the other involved a goods vehicle colliding with a pedestrian.

- 3.10.7 Five further collisions involving vehicles only occurred along Ordsall Road and West Hill Road. Four of these incidents were classified as slight in severity, three of which involved cars performing conflicting movements at junctions, whilst the remaining collision involved a standing passenger on a bus falling. The remaining one incident at was classified as serious in severity and involved two cars travelling in opposite directions colliding during hours of darkness.
- 3.10.8 Two incidents occurred at the Ollerton Road/West Hill Road junction. These incidents involved vehicles only, one of which was classified as slight in severity and involved a car turning right onto Ollerton Road (south) and colliding with a motorcycle travelling south on Ollerton Road in wet conditions. The remaining collision was classified as serious in severity and involved one vehicle turning left onto Ollerton Road (south) and colliding with a car travelling north on Ollerton Road.
- 3.10.9 One incident occurred along the National Speed Limit section of Ollerton Road at the Ollerton Road/Main Road junction and involved vehicles only. The incident was classified as slight in severity.
- 3.10.10 A total of four collisions occurred along Goosemoor Lane and Whitehouses Road, two of which occurred at the London Road/Whitehouses Road mini roundabout junction. Both incidents at the mini roundabout were classified as slight in severity and involved cars performing conflicting movements at the junction. The one fatality in the study area occurred on Goosemoor Lane/Whitehouses Road and involved a car turning right into Goosemoor Produce Farm Shop and colliding with a motorcycle. The final incident that occurred on Goosemoor Lane involved a car colliding with a pedestrian during the early hours of the morning and was classified as slight in severity.
- 3.10.11 The collisions that occurred throughout the study area do not suggest any spatial clustering or clear causal trends. No collisions occurred at or near to the Ollerton Road site frontage. It is therefore concluded that there are no existing road safety issues which are likely to be exacerbated by future development at the site.

4 DEVELOPMENT ASSUMPTIONS

4.1 INTRODUCTION

4.1.1 For this TA, a development consisting of 930 dwellings at the Ordsall South site has been assumed. A sensitivity test including an additional 320 dwellings at the Ordsall South site has also been undertaken.

4.2 SITE ACCESS STRATEGY

4.2.1 Ollerton Road bisects the site and is the only existing adopted highway from which vehicular access can be provided. It has been assumed that the site will be accessed from two new roundabouts onto Ollerton Road with land to the east and west of Ollerton Road accessed from separate arms onto the roundabouts. Land to the west will be accessed from both roundabouts and land to the east will be accessed from one roundabout. A concept layout depicting a possible site access strategy has been prepared by the consultant working on behalf of the site promoter and is provided in **Appendix E**.

4.2.2 The concept layout shows footways and segregated cycleways on all the site access arms. Footways are also shown on both sides of Ollerton Road between the two site access roundabouts and to the north. Segregated cycleways are shown on the western side of Ollerton Road between the two site access roundabouts and on both sides of Ollerton Road to the north.

4.2.3 The concept layout does not impact on any existing public rights of way (PROW).

4.3 INTERNAL SITE LAYOUT

4.3.1 The internal layout of the site will need to be designed to provide a road network in which pedestrian and cyclist movements are prioritised. The road network should allow for future bus access into the site as set out in **Chapter 5**. The internal layout of the site should have a 20mph design speed throughout.

4.3.2 The opportunity should be taken to maximise connectivity for pedestrians and cyclists with adjoining areas. Wherever possible, it is recommended that the alignment of any existing PROW remains as per existing.

4.4 SERVICE AND EMERGENCY VEHICLES

4.4.1 Service and emergency vehicles will gain access to the development via the same route as other vehicular traffic.

4.5 PEOPLE WITH DISABILITIES AND OTHER MOBILITY IMPAIRMENTS

- 4.5.1 The detailed design of the development and its internal transport infrastructure will be undertaken in accordance with the requirements of the 2010 Equality Act and in accordance with current good practice as embodied within the DfT's 'Inclusive Mobility' document.
- 4.5.2 This approach will ensure that the completed development is fully inclusive and meets the needs of all users, including those with disabilities or temporary mobility impairments.
- 4.5.3 The requirement to design for disabled people will permeate all aspects of the design process and will include access to and movement within the site, but also the interface between the development and the surrounding highway network and in particular, the pedestrian routes and public transport facilities.

5 OPPORTUNITIES TO IMPROVE SUSTAINABLE TRANSPORT INFRASTRUCTURE

5.1 WALKING AND CYCLING

5.1.1 As outlined in **Chapter 3**, southern parts of Retford are within reasonable walking distance of the site and all of Retford is within reasonable cycling distance.

5.1.2 The 'Grey to Green Retford Walking and Cycling Audit' prepared by Tetra Tech in 2021 identified a series of recommendations and priorities for improving walking and cycling in Retford. There would be the opportunity for development of the Ordsall site to contribute towards delivery of some of these recommendations and priorities.

5.1.3 As a minimum, development at the site should provide connections with existing infrastructure adjoining and near to the site.

5.1.4 Pedestrian infrastructure is already of a reasonable standard but there may be locations for example, where improved crossing facilities could be provided, or a footway could be widened. As any development proposals are worked up, consideration should be given to likely pedestrian desire lines, and this should inform improvements to pedestrian infrastructure. This should focus on routes to key trip attractors such as schools, shops, and the train station.

5.1.5 Improvements to cycle infrastructure should focus on routes to Retford town centre and Retford Train Station. There could be an opportunity for some of the priority links identified in the 'Grey to Green Retford Walking and Cycling Audit' to be improved as part of development at the site, particularly the Babworth Road and London Road corridors. Any improvements should be Local Transport Note (LTN) 1/20 compliant. Where cycle infrastructure cannot meet the requirements of LTN 1/20, this should be discussed with NCC. NCC will be required to advise if the developer should provide cycle infrastructure that meets the requirements LTN as best it can but acknowledging that it will not be fully LTN 1/20 compliant, or alternatively, if cycle infrastructure should not be provided.

5.1.6 The opportunity to contribute to or safeguard a new strategic walking or cycling route should also be taken, for example any proposals for a walking/cycling corridor between Retford and Worksop; and/or improved links to Retford Train Station.

5.2 BUS SERVICES

5.2.1 Whilst existing bus stops are located within the recommended 400m of the site boundary, large parts of the site are further than 400m from an existing bus stop. In addition, existing bus services stopping at the nearest bus stops to the site are not high frequency services.

- 5.2.2 The site layout should be designed in a manner that allows bus access into the site. As a minimum, bus services should access the western parcel of the site. Subject to discussions with NCC and local bus operators, if bus stops are provided on Ollerton Road near the site access, the need for buses to access the eastern parcel of the site could be removed.
- 5.2.3 To future proof the site, the western and eastern parcels should both be designed to allow future bus access. The western parcel of the site should include a loop road arrangement to allow bus penetration into the site. A development of 930 dwellings should be of a suitable scale to enable developer funding of a new or extended bus service. To encourage modal shift from single occupancy car to bus, it is likely that a 30-minute frequency service would be required. It is typically the case that developers would fund a bus service for five years. After five years the idea is that the service would be sustainable without the need for financial support. This would need to be explored in further detail. The risk is that if the service is not sustainable and additional support is not available, the bus service would cease to operate or would operate a reduced timetable.
- 5.2.4 As a guide, the cost to operate one single deck bus for one year is circa £175k excluding any revenue generated from ticket sales.

5.3 TRAIN SERVICES

- 5.3.1 The site benefits from its proximity to Retford Train Station and as set out in this chapter, efforts should be made to maximise connectivity with the train station. Travel by train provides a genuine opportunity for future residents to undertake longer journeys by train rather than single occupancy car. As noted earlier in this report, the condition of the underpass beneath the railway line between Station Road and Tunnel Road may discourage people from using this route. Development of the site may provide an opportunity to improve the condition of the underpass.

6 FUTURE TRAFFIC FLOWS

6.1 FORECAST GROWTH

6.1.1 Traffic growth factors for a 2021 base year and a future design year of 2038 have been derived using TEMPro software, for the 'Bassetlaw 010' Middle Super Output Area (MSOA). The TEMPro outputs are presented in **Appendix E** and the resulting growth factors are shown below.

- 2016 to 2021 AM = 1.080
- 2016 to 2021 PM = 1.076
- 2017 to 2021 AM = 1.064
- 2017 to 2021 PM = 1.060
- 2018 to 2021 AM = 1.048
- 2018 to 2021 PM = 1.045
- 2021 to 2032 AM = 1.120
- 2021 to 2032 PM = 1.119
- 2032 to 2038 AM = 1.044
- 2032 to 2038 PM = 1.043

6.1.2 The 2038 assessment year has been selected because it is the end year of the Local Plan.

6.1.3 It should be noted that there is considerable uncertainty regarding future traffic flows in the years ahead and whether traffic will return to pre-Covid levels. It is widely accepted that there will be an increase in home working and therefore less commuter travel in typical rush hour periods. There is also likely to be a decrease in public transport use for a period with people perhaps favouring the car. The Department for Transport has not issued revised growth forecasts, but the increases indicated in TEMPro for the period to 2038 are perhaps higher than may ultimately prove to be the case. Nevertheless, this TA uses TEMPro growth forecasts and therefore presents a robust assessment of future background traffic levels.

6.2 COMMITTED DEVELOPMENTS

6.2.1 Committed schemes are defined as developments or transport schemes which have current planning consent, but which are unimplemented or incomplete, and could in the future have a significant impact on transport conditions or the layout of the local highway network. NCC has confirmed that the following committed development should be included in this TA:

- Application 14/00503/OUT - Outline Application for the Erection of up to 175 Dwellings Including Public Open Space, Attenuation Drainage Basin and Associated Works. The site is located off Tiln Lane.
- Application 15/00493/OUT - Outline Planning Application for a Mixed Use Development of up to 196 dwellings and 11.11ha of Employment Land with All Matters Reserved Except Access. The site is located off North Road.
- Application 16/00015/FUL - Hybrid Planning Application, comprising: A) Full Application for New Manufacturing Building (Class B2) and Two Storey Offices (B1), with Associated Parking and Refurbishment and Change of Use to Class A1/A3/B1 or D1 Use for Former Northern Rubber Tower Building. B) Outline Application for the Erection of A Convenience Supermarket (A1), Freestanding Hot Food Restaurant or Take Away (A3/A5) and A Single Storey Building for Non Food Retail and Leisure Use (A1/D2) With Associated Access, Car Park, and Service Infrastructure. The site is located off London Road/South Street/Thrumpton Lane.
- Application 16/01777/FUL – Demolition of Nursery Buildings and Erection of 113 Dwellings together with Access to London Road and Creation of Public Open Space. The site is located at Kenilworth Nurseries, London Road.
- Application 18/00695/FUL – Erect 109 Dwellings and Construct New Access Including Provision of Public Open Space and Surface Water Balancing Pond. The site is located at Kenilworth Nurseries, London Road.

6.2.2 The TAs for the above developments have been reviewed and the development traffic flows have been obtained. Committed development trips have been added to the background traffic flows in this TA. Committed development flows are presented in **Appendix G**.

6.3 OTHER POSSIBLE LOCAL PLAN DEVELOPMENT SITES

6.3.1 As requested by BDC, development trips from the other six housing allocation sites in the Draft Local Plan (i.e. in addition to Ordsall South) have also been taken into consideration in this TA. The following housing allocations have been considered:

- HS7 Trinity Farm, Retford – 244 dwellings
- HS8 Milnercroft, Retford – 5 dwellings
- HS9 Former Elizabethan School, Retford – 46 dwellings
- HS10 St. Michael's View, Hallcroft Road, Retford – 20 dwellings
- HS11 Fairy Grove, Grove Road, Retford – 61 dwellings

- HS12 Station Road, Retford – 5 dwellings

6.3.2 Development trip generation has been calculated and trips have been distributed onto the existing highway network. The approach taken for trip generation and distribution is the same as the approach taken for the Ordsall site. This is explained in **Chapters 7 and 8**. Traffic flows from these sites are presented in **Appendix H**.

6.3.3 This TA includes assessments ‘with’ and ‘without’ trips associated with the other possible development sites taken into consideration. No additional sites other than those identified in this Chapter have been taken into consideration.

6.4 APLEYHEAD AND PEAKS HILL FARM

6.4.1 As requested by NCC, development trips associated with the proposed major allocations at Apleyhead and Peaks Hill Farm have been considered. For this TA, a development of 216ha of employment has been assessed at Apleyhead and a development of 1,000 dwellings and 5ha of employment has been assessed at Peaks Hill Farm. There are no other allocations proposed within the District that will have a material effect on traffic conditions in Retford.

6.4.2 Apleyhead and Peaks Hill Farm trips have been distributed using a VISUM model¹. The model uses Census 2011 Journey to Work data and assigns trips to the network using an ‘all or nothing’ assignment onto routes with the shortest / quickest journey times.

6.4.3 Vehicle trips associated with the Apleyhead and Peaks Hill Farm allocation sites have then been manually combined with the development trips generated by the proposed allocation sites in Retford that are the subject of this report. Traffic flows from the Apleyhead and Peaks Hill Farm site are presented in **Appendix H**.

6.4.4 Vehicle trips from the Apleyhead and Peaks Hill Farm allocation sites have been manually added to background traffic flows at the following junctions:

- Junction 2A - Apleyhead Interchange (A57 /Blyth Road / A1)
- Junction 6 - A620 Babworth Rd/B6420 Mansfield Rd/A620 Straight Mile/Sutton Lane
- Junction 7 - A620 Babworth Road/Ordsall Road

6.4.5 Apleyhead and Peaks Hill Farm development trips are lower at all other study area junctions and therefore assumed to be accounted for as part of general background traffic growth.

¹ The same VSUM model as used for the Bassetlaw Transport Study.

7 TRIP GENERATION

7.1 TRIP GENERATION

7.1.1 Development trip generation has been calculated using trip rates obtained from the TRICS database. The category 'Residential – Houses Privately Owned' was interrogated for sites in England, Scotland, and Wales, excluding Greater London. The data was obtained for the highway peak periods of 0800-0900 hrs and 1700-1800hrs. As requested by NCC, sites listed as 'mixed housing' or 'flats' were removed from the selection.

7.1.2 The full TRICS outputs are presented in **Appendix I** and the resultant trip rates are summarised in **Table 7** and **Table 8** as follows. The trip rates in **Table 7** have been used to calculate trip generation for the Ordsall South and Trinity Farm Local Plan allocation sites identified in **Section 6.3**. The trip rates in **Table 8** have been used to calculate trip generation at all other Local Plan allocation sites considered in this TA². Trip rates have been agreed with NCC.

Table 7 - Residential Trip Rates by Mode (Houses Privately Owned)

Mode	AM (08:00-09:00)			PM (17:00-18:00)		
	Arrivals	Departures	Total	Arrivals	Departures	Total
Vehicles	0.160	0.441	0.601	0.407	0.179	0.586
Taxis	0.006	0.007	0.013	0.000	0.001	0.001
OGVs	0.000	0.000	0.000	0.000	0.000	0.000
PSVs	0.002	0.001	0.003	0.000	0.000	0.000
Cyclists	0.004	0.022	0.026	0.016	0.007	0.023
Vehicle Occupants	0.175	0.705	0.880	0.559	0.249	0.808
Pedestrians	0.041	0.152	0.193	0.038	0.052	0.090
Public Transport Users	0.000	0.008	0.008	0.006	0.001	0.007
Total People	0.221	0.888	1.109	0.618	0.309	0.927

Table 8 - Residential Trip Rates by Mode (Houses Privately Owned)

Mode	AM (08:00-09:00)			PM (17:00-18:00)		
	Arrivals	Departures	Total	Arrivals	Departures	Total
Vehicles	0.163	0.340	0.503	0.393	0.206	0.599
Taxis	0.000	0.000	0.000	0.000	0.000	0.000
OGVs	0.000	0.000	0.000	0.000	0.000	0.000
PSVs	0.006	0.006	0.012	0.000	0.000	0.000
Cyclists	0.000	0.012	0.012	0.009	0.006	0.015
Vehicle Occupants	0.175	0.500	0.675	0.552	0.310	0.862
Pedestrians	0.052	0.172	0.224	0.049	0.049	0.098
Public Transport Users	0.003	0.009	0.012	0.006	0.003	0.009
Total People	0.230	0.693	0.923	0.617	0.368	0.985

² It should be noted that the traffic generation rates of individual development sites could be greater than those applied for the purposes of this strategic study depending on the specific nature of each development. Detailed Transport Assessments will therefore be required in support of developments at the planning application stage.

7.1.3 Using the trip rates presented in **Table 7** and **Table 8** the resultant development trip generation of all allocation sites is shown in the following tables.

Table 9 - Residential Trip Generation by Mode (allocation HS13 – 930 Dwellings)

Mode	AM (08:00-09:00)			PM (17:00-18:00)		
	Arrivals	Departures	Total	Arrivals	Departures	Total
Vehicles	149	410	559	379	166	545
Taxis	6	7	12	0	1	1
OGVs	0	0	0	0	0	0
PSVs	2	1	3	0	0	0
Cyclists	4	20	24	15	7	21
Vehicle Occupants	163	656	818	520	232	751
Pedestrians	38	141	179	35	48	84
Public Transport Users	0	7	1	6	1	7
Total People	206	826	1,031	575	287	862
PCUs	149	410	559	379	166	545

Table 10 - Residential Trip Generation by Mode (Allocation HS7 - 244 Dwellings)

Mode	AM (08:00-09:00)			PM (17:00-18:00)		
	Arrivals	Departures	Total	Arrivals	Departures	Total
Vehicles	39	108	147	99	44	143
Taxis	1	2	3	0	0	0
OGVs	0	0	0	0	0	0
PSVs	0	0	1	0	0	0
Cyclists	1	5	6	4	2	6
Vehicle Occupants	43	172	215	136	61	197
Pedestrians	10	37	47	9	13	22
Public Transport Users	0	2	2	1	0	2
Total People	54	217	271	151	75	226
PCUs	39	108	147	99	44	143

Table 11 - Residential Trip Generation by Mode (Allocation HS8 - 5 Dwellings)

Mode	AM (08:00-09:00)			PM (17:00-18:00)		
	Arrivals	Departures	Total	Arrivals	Departures	Total
Vehicles	1	2	3	2	1	3
Taxis	0	0	0	0	0	0
OGVs	0	0	0	0	0	0
PSVs	0	0	0	0	0	0
Cyclists	0	0	0	0	0	0
Vehicle Occupants	1	3	3	3	2	4
Pedestrians	0	1	1	0	0	0
Public Transport Users	0	0	0	0	0	0
Total People	1	3	5	3	2	4
PCUs	1	2	3	2	1	3

Table 12 - Residential Trip Generation by Mode (Allocation HS9 - 46 Dwellings)

Mode	AM (08:00-09:00)			PM (17:00-18:00)		
	Arrivals	Departures	Total	Arrivals	Departures	Total
Vehicles	7	16	23	18	9	28
Taxis	0	0	0	0	0	0
OGVs	0	0	0	0	0	0
PSVs	0	0	1	0	0	0
Cyclists	0	1	1	0	0	1
Vehicle Occupants	8	23	31	25	14	40
Pedestrians	2	8	10	2	2	5
Public Transport Users	0	0	1	0	0	0
Total People	11	32	42	28	17	45
PCUs	7	16	23	18	9	28

Table 13 - Residential Trip Generation by Mode (Allocation HS10 - 20 Dwellings)

Mode	AM (08:00-09:00)			PM (17:00-18:00)		
	Arrivals	Departures	Total	Arrivals	Departures	Total
Vehicles	3	7	10	8	4	12
Taxis	0	0	0	0	0	0
OGVs	0	0	0	0	0	0
PSVs	0	0	0	0	0	0
Cyclists	0	0	0	0	0	0
Vehicle Occupants	4	10	14	11	6	17
Pedestrians	1	3	4	1	1	2
Public Transport Users	0	0	0	0	0	0
Total People	5	14	18	12	7	20
PCUs	3	7	10	8	4	12

Table 14 - Residential Trip Generation by Mode (Allocation HS11 - 61 Dwellings)

Mode	AM (08:00-09:00)			PM (17:00-18:00)		
	Arrivals	Departures	Total	Arrivals	Departures	Total
Vehicles	10	21	31	24	13	37
Taxis	0	0	0	0	0	0
OGVs	0	0	0	0	0	0
PSVs	0	0	1	0	0	0
Cyclists	0	1	1	1	0	1
Vehicle Occupants	11	31	41	34	19	53
Pedestrians	3	10	14	3	3	65
Public Transport Users	0	1	1	0	0	1
Total People	14	42	56	38	22	60
PCUs	10	21	31	24	13	37

Table 15 - Residential Trip Generation by Mode (Allocation HS12 - 5 Dwellings)

Mode	AM (08:00-09:00)			PM (17:00-18:00)		
	Arrivals	Departures	Total	Arrivals	Departures	Total
Vehicles	1	2	3	2	1	3
Taxis	0	0	0	0	0	0
OGVs	0	0	0	0	0	0
PSVs	0	0	0	0	0	0
Cyclists	0	0	0	0	0	0
Vehicle Occupants	1	3	3	3	2	4
Pedestrians	0	1	1	0	0	0
Public Transport Users	0	0	0	0	0	0
Total People	1	3	5	3	2	5
PCUs	1	2	3	2	1	3

8 TRIP DISTRIBUTION

8.1 TRIP DISTRIBUTION

8.1.1 The external vehicle trip generation summarised in **Chapter 7** has been distributed onto the local highway network based upon 2011 Journey to Work (JTW) data for Bassetlaw 010 middle super output area (MSOA). Using GIS and HERE road data, the trips identified within the JTW data were routed to their corresponding origin/destination MSOAs using the Ollerton Road site frontage as the origin point for Bassetlaw 010 MSOA.

8.1.2 Trips that remain within the Bassetlaw 010 MSOA within the 2011 census data are assumed to travel to/from a point on Ollerton Road north of the Ollerton Road/West Hill Road but south of Babworth Road.

8.1.3 The road network used in this assessment covers the Bassetlaw district. Within the network area there are zones that match the MSOA boundaries, the connection of these zones to the network (model connectors), where trips enter and leave the network for the purposes of assignment, is taken to be a point in the largest urban centre within the MSOA. Trips that do not originate or terminate at an MSOA within the network area are allocated an 'exit' zone of the network on the link that they would exit the network along. The distribution percentage for all MSOAs that would use each exit zone is aggregated together to provide a distribution percentage for that zone.

8.1.4 Development trips have been distributed as follows:

- A1 (north) – 11%
- Retford Road (to/from Worksop) – 7%
- A57 (to/from Worksop) – 5%
- A614 Blyth Road – 8%
- Dover Bottom – 2%
- A57 (to/from Lincoln) – 2%
- A1 (south) and Great North Road – 21%
- Carolgate (to/from Retford town centre) – 11%
- Chapel Gate (to/from Retford town centre) – 4%
- Moorgate (east of Retford) – 5%
- Hallcroft Road – 9%
- Sutton Lane - 11%
- Whiney Moor Lane - 4%

8.2 TRIP ASSIGNMENT

8.2.1 VISUM software was used to assign the generated development trips onto the network. The development trips were compiled into a matrix based upon the distribution percentages to each

zone from the JTW MSOA analysis. The trips were assigned to the network using an 'all or nothing' assignment, with trips taking the shortest route based upon journey time. There is no trip reassignment or delays / congestion included within the model.

8.2.2 The link speeds within VISUM were based upon the mandatory speed limits which were adjusted where required to reflect observed driver behaviour. The routing generated within the model was compared to suggested routings from Google's mapping engine that considers historic average traveling speeds on links based on congestion and the quality of the link. This indicated that in some cases rural national speed limit (60mph) links were being selected by VISUM, when in practice the actual speed of travel would be lower, and an alternative route may provide a quicker journey as it would be possible to travel faster albeit with a lower mandatory speed limit. Therefore, link speeds were adjusted on some links to force routing to match the routes observed in Google Maps.

8.2.3 In addition, specific consideration has been given to the route between the site and the Markham Moor junction. The VISUM model initially distributed all trips between the site and the Markham Moor junction (except A1 (north) trips) via Main Road through Eaton village. Whilst Main Road is subject to the National Speed Limit, some sections are narrow, and visibility is reduced in places. As such, the journey time along Main Road can be slower than for other routes which could make it less attractive than some alternative route options. **Table 16** indicates the distance and journey time between the site and the Markham Moor junction using different route options.

Table 16 - Distance and Journey Time to Markham Moor Junction

Route	Distance	Journey Time
Via Main Road (Eaton)	6.9km	7 minutes
Via High Street and Goosemoor Lane	8.2km	8 minutes
Via Brick Yard Lane	8.9km	8 minutes

8.2.4 Furthermore, specific consideration was also given to the route between the site and Worksop. As discussed with NCC, there are three likely routes to Worksop as indicated in **Table 17**.

Table 17 - Distance and Journey Time to Worksop (A57/B6040 Roundabout)

Route	Distance	Journey Time
Via B6420 and A57	11.3km	12 minutes
Via Jockey Lane and A1	13.5km	12 minutes
Via A620, B6079 and A57	11.7km	12 minutes

- 8.2.5 Driver choice will vary between individual but on balance, for the purpose of this TA, trips to/from the Markham Moor junction have been split equally between the three route options in **Table 16** and trips to/from Worksop have been split equally between the three route options in **Table 17**.
- 8.2.6 For this TA, it is assumed that 75% of development trips will be to/from the western parcel of the site and 25% will be to/from the eastern parcel of the site.
- 8.2.7 The resultant AM/PM peak period development trip distribution on the highway network near the site is shown in **Appendix J**.

9 HIGHWAY IMPACTS

9.1 IMPACTS

9.1.1 Estimated two-way development traffic impacts on key local links are shown in **Table 18** below.

Table 18 - Two-Way Ordsall South Development Traffic Impacts on Links (PCUs)

Road Link	Development Flows (930 Dwellings)		Development Flows (1,250 Dwellings)	
	AM	PM	AM	PM
Babworth Road (west of Ordsall Rd)	212	207	285	278
Babworth Road (east of Ordsall Rd)	78	76	105	103
A1 (north)	61	60	83	81
A1 (south)	65	49	88	65
A620 Amcott Way	28	27	38	37
A620 Moorgate	28	27	38	37
A638 Arlington Way	22	22	30	29
A638 London Road	67	75	145	144
A638 (south of Main Road)	101	96	136	129
Main Road	54	53	73	71
Goosemoor Lane	155	151	208	203
Brick Yard Lane	65	64	88	85
A57 (east)	11	11	15	14
A57 (west)	22	22	30	29
Great North Road	86	84	115	112

9.1.2 **Table 19** on the next page shows the increase in vehicle trips at each study area junction. Full calculations are presented in **Appendix J**.

Table 19 - Two-Way Ordsall South Development Traffic Impacts at Junctions (PCUs)

Ref	Junction	Development Flows				Test
		930 Dwellings		1,250 Dwellings		
		AM	PM	AM	PM	
1A	A1 / B6079 Retford Road	67	40	91	54	*
1B	A1 / A620 Retford Road	84	82	113	110	*
2A	Apleyhead Interchange (A57 /Blyth Road / A1)	67	65	90	88	*
2B	A1 / B6420 Mansfield Road / A614 Blyth Road / A57	67	65	90	88	*
3	Elkesley Bridge Road / A1 Worksop Road	49	57	66	77	*
3B	Jockey Lane / Eskil Way	65	64	88	85	*
4A	A1 / B6387 Dover Bottom (North)	11	11	15	15	
4B	A1 / B6387 Dover Bottom (South)	11	11	15	15	
5A	Markham Moor Interchange (A638 / A57 Cliff gate / A57 / A1)	86	84	115	112	*
5B	A1 Markham Moor (A1 / Great N Road / Main Street / A57)	31	79	42	107	*
6	A620 / B6420 Mansfield Rd / A620 Straight Mile / Sutton Lane	212	207	285	278	*
7	A620 Babworth Road / Ordsall Road	291	283	391	381	*
8	A620 / Bridlegate / A620 Hospital Rd / A638 North Rd / Hallcroft Rd	78	76	105	103	*
9	A620 Amcott Way / A620 Moorgate / A638 Arlington Way	28	27	38	37	*
10	A638 Arlington Way / Spital Hill / Chapelgate	22	22	30	29	*
11	A638 Arlington Way / Grove Street	16	7	22	9	*
12	A638 Arlington Way / A638 London Road / Carolgate	84	82	113	110	*
13	Ollerton Road / W Hill Road	445	434	598	584	*
14	London Road / Whitehouses Road	184	151	248	203	*
15	London Road / Whinney Moor Lane / Bracken Lane	106	104	143	139	*
16	All Hallows Street / High Street / Goosemoor Lane	155	151	208	203	*
17	Site Access / Ollerton Road	559	511	751	687	*
18	Ollerton Road / Brick Yard Road	119	116	160	156	*
19	A638 / Main Road	97	94	130	127	*
20	A638 / B6387 Rectory Lane	101	96	136	129	*

Note: Junctions with red asterisks are discussed further in Chapter 11.

9.1.3 NCC has indicated that capacity assessments should be undertaken at locations where an increase of 30 or more trips is forecast in the AM or PM peak hour. Based on the highway impacts in **Table 19**, capacity assessments are required at all off-site junctions in the study area except Junction 4. Junctions where capacity assessments have been undertaken are indicated with red asterisks.

9.1.4 The number of junctions where an increase of 30 or more trips is forecast in the AM or PM peak hour is significant. For any junctions shown to operate above capacity following the addition of development traffic, NCC may require mitigation. Any mitigation will need to be directly related to the proposed development and must be proportionate to the scale of impact.

9.1.5 It should be noted that just because a junction is forecast to have an increase in trips greater than 30 PCUs in the AM or PM peak hour does not necessarily mean that physical mitigation in

the form of highway improvements will be required. There may be 'spare' traffic capacity available at some junctions that can accommodate development trips without improvement. Alternatively, providing enhanced walking, cycling and public transport connections will also help to reduce development traffic impacts at off-site junctions.

9.2 HIGH STREET / GOOSEMOOR LANE

9.2.1 At locations where highway capacity is exceeded, it is usually the case that junction capacity is the issue rather than link capacity. Nevertheless, the capacity of High Street / Goosemoor Lane is worth specific consideration in this instance as it was identified by NCC as a potential constraint during preliminary discussions. Trip distribution calculations show an increase of 155 and 151 PCUs during the AM and PM peak hours respectively for a development of 930 dwellings at Ordsall South. For the sensitivity test of 1,250 dwellings at Ordsall South, trip distribution calculations show an increase of 208 and 203 PCUs during the AM and PM peak hours respectively.

9.2.2 Goosemoor Lane has a typical width which varies between 6.0m and 7.5m, although it narrows to circa 5.3m at the bridge over the River Idle. High Street has a typical width between 5.8m and 6.5m. On-street parking occurs on the eastern side of High Street to the north of Farm View and to the south of Southgate. Occasional on-street parking occurs elsewhere on High Street. On-street parking effectively restricts the available carriageway width to one-way flow.

9.2.3 Guidance on link capacity was provided in Volume 5 of the Design Manual for Roads and Bridges (DMRB) in TA 79/99 'Traffic Capacity of Urban Roads' and TA 46/97 'Traffic Flow Ranges for use in the Assessment of New Rural Roads'. Both documents were withdrawn in March 2020. However, in the absence of any replacement guidance, the withdrawn guidance has been used to assess link capacity in this TA. TA 79/99 defines an urban road as 'an all-purpose road within a built up area, either a single carriageway with a speed limit of 40mph or less or a dual carriageway with a speed limit of 60mph or less.'. TA 46/97 defines rural roads as 'all-purpose roads and motorways that are generally not subject to a local speed limit'. On this basis, High Street is an urban road and Goosemoor Lane is a rural road. Therefore, for the purposes of this assessment, forecast link flows on High Street have been assessed using TA 79/99 and forecast link flows on Goosemoor Lane have been assessed using TA 46/97.

High Street

9.2.4 Comparing the characteristics of High Street to Table 1 of TA79/99 shows it is classed as an Urban All-Purpose (UAP3) road "Variable standard road carrying mixed traffic with frontage access, side roads, bus stops and at-grade pedestrian crossings, 30 to 40mph speed limit, with frontage access". Table 2 of TA79/99 shows that 6.1m and 7.3m wide UAP3 category roads have a one-way hourly capacity in each direction equivalent to 900 and 1,300 VPH respectively (busiest direction of flow assuming a 60/40 directional split).

9.2.5 Calculations in **Appendix J** indicate that by 2038 in the 'Base + Committed Developments + Ordsall South + Other Local Plan Sites' scenario, one-way flows are less than 900 when considering 930 or 1,250 dwellings at Ordsall South. In the scenario with 1,250 dwellings at Ordsall South, the highest one-way directional flow is 340 in the AM peak hour and 314 in the PM peak hour. Flows are therefore considerably lower than the maximum capacity of urban roads indicated in TA 79/99, although it is acknowledged that on-street parking will effectively reduce the available link capacity and High Street is therefore likely to require further consideration as part of any planning application.

Goosemoor Lane

9.2.6 TA 46/97 provides the equation below for calculating the link capacity of rural roads where:

$$\text{Capacity} = [A - B * Pk\%H]$$

Where for single carriageways A = 1,380, B = 15 and Pk%H is the percentage of Heavy Vehicles in the peak hour.

9.2.7 The percentage of Heavy Vehicles in the peak hours has been obtained from the traffic counts undertaken at the London Road/Whitehouses Road and High Street/Goosemoor Lane junctions. The percentage of Heavy Vehicles was higher at the London Road/Whitehouses Road junction (2.3%) and has been used in the TA 46/97 capacity calculation. Applying the observed 2.3% percentage of Heavy Vehicles in the peak hour for Pk%H gives the maximum Rural Link capacity of 1,345 in each direction.

9.2.8 Calculations in **Appendix J** indicate that by 2038 in the 'Base + Committed Developments + Ordsall South + Other Local Plan Sites' scenario, one-way flows are less than 1,345 when considering 930 or 1,250 dwellings at Ordsall South. In the scenario with 1,250 dwellings at Ordsall South, the highest one-way directional flow is 666 in the AM peak hour and 717 in the PM peak hour. Flows are therefore considerably lower than the maximum capacity of rural roads indicated in TA 46/97, although it is acknowledged that on-street parking will effectively reduce the available link capacity and Goosemoor Lane is therefore likely to require further consideration as part of any planning application.

9.3 MAIN ROAD

9.3.1 As with High Street / Goosemoor Lane, the capacity of Main Road through Eaton village is worth specific consideration in this instance as it was identified by NCC as a potential constraint during preliminary discussions. Trip distribution calculations show an increase of 54 and 53 PCUs during the AM and PM peak hours respectively for a development of 930 dwellings at Ordsall South. For the sensitivity test of 1,250 dwellings at Ordsall South, trip distribution calculations show an increase of 73 and 71 PCUs during the AM and PM peak hours respectively. Main Road

is therefore likely to require further consideration as part of any planning application. This is discussed further in **Chapter 11**.

9.3.2 As requested by NCC, a sensitivity test has also been undertaken whereby trips to/from Markham Moor have been split across two routes rather than three as per the trip distribution set out in **Section 8.2**. For the sensitivity test, trips to/from Markham Moor have been split between Main Road (Eaton) and Brick Yard Lane. Trips assigned to Goosemoor Lane and High Street have instead been assigned to Main Road (Eaton). Trips assigned to Brick Yard Lane have not been amended for the sensitivity test. In the sensitivity test, Ordsall South trips assigned to Main Road increase from 10% to 17%. For a development of 930 dwellings at Ordsall South, this equates to 95 and 93 two-way PCUs in the AM and PM peak hours respectively. For a development of 1,250 dwellings at Ordsall South, this equates to 128 and 125 two-way PCUs during the AM and PM peak hours respectively.

9.3.3 Using the guidance in TA 79/99 and TA 46/97, the eastern part of Main Road is defined as a rural road and the western part of Main Road is defined as an urban road. Therefore, for the purpose of assessing link capacity, forecast link flows on Main Road (east) have been assessed using TA 79/99 and forecast link flows on High Street (west) have been assessed using TA 46/97.

Main Road (east)

9.3.4 Comparing the characteristics of High Street to Table 1 of TA79/99 shows it is classed as an Urban All-Purpose (UAP3) road “Variable standard road carrying mixed traffic with frontage access, side roads, bus stops and at-grade pedestrian crossings, 30 to 40mph speed limit, with frontage access”. Main Road (east) has a typical width of less than 6.1m (the minimum in Table 2 of TA79/99). Table 2 of TA 79/99 shows that 6.1m wide UAP3 category roads have a one-way hourly capacity in each direction equivalent to 900 VPH (busiest direction of flow assuming a 60/40 directional split).

9.3.5 Calculations in **Appendix J** indicate that by 2038 in the ‘Base + Committed Developments + Ordsall South + Other Local Plan Sites’ scenario, one-way flows are less than 900 when considering 930 or 1,250 dwellings at Ordsall South. In the scenario with 1,250 dwellings at Ordsall South, the highest one-way directional flow is 190 in the AM peak hour and 207 in the PM peak hour. Flows are therefore considerably lower than the maximum capacity of urban roads indicated in TA 79/99.

Main Road (west)

9.3.6 For input into the TA 46/96 formula in paragraph 9.2.6, the percentage of Heavy Vehicles in the peak hours has been obtained from the traffic count undertaken at the London Road/Main Road junction. The percentage of Heavy Vehicles was 1.9% and has been used in the TA 46/97

capacity calculation. Applying the observed 1.9% percentage of Heavy Vehicles in the peak hour for Pk%H gives the maximum Rural Link capacity of 1,352 in each direction.

9.3.7 Calculations in **Appendix J** indicate that by 2038 in the 'Base + Committed Developments + Ordsall South + Other Local Plan Sites' scenario, one-way flows are less than 1,352 when considering 930 or 1,250 dwellings at Ordsall South. In the scenario with 1,250 dwellings at Ordsall South, the highest one-way directional flow is 120 in the AM peak hour and 127 in the PM peak hour. Flows are therefore considerably lower than the maximum capacity of rural roads indicated in TA 46/97.

9.3.8 The assessment of link capacity on High Street, Goosemoor Lane and Main Road has also demonstrated that there is sufficient link capacity on High Street / Goosemoor Lane to accommodate any re-assignment of traffic from Main Road if measures are introduced to deter traffic from using Main Road.

9.4 LINK ROAD FEASIBILITY

9.4.1 A previous suggestion from residents in the Ordsall area is for the provision of a new link road between Ollerton Road and the A638. The logic behind this suggestion is that a new link road would help to relieve existing pressure on Goosemoor Lane and its junctions onto High Street at its western end and London Road at its eastern end. A new link road would also allow development traffic to easily access the A638 London Road without having to use Main Road through Eaton Village, which is unsuitable for any significant increase in use due to its alignment, width, and character through the village. An indicative location and alignment for the suggested new link road is shown in the image below.

Indicative Link Road between Ollerton Road and the A638

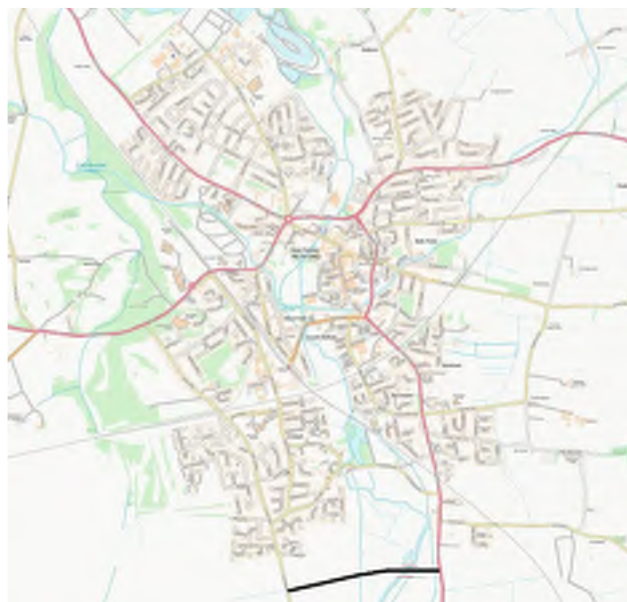

9.4.2 A very high-level appraisal has been undertaken which has identified that delivering a new link road at this location would not be straight forward because the road will be crossing flood plain and a new bridge will be required over the River Idle. To avoid potential flooding issues the road would probably need to be constructed as an elevated carriageway, which would have implications for cost, flood risk and environmental impacts. Further detailed appraisal will therefore be required to investigate its feasibility.

9.4.3 Based on a very high-level appraisal the anticipated cost to provide a new link road at this location could be in the order of £10m considering the length of the link road (circa 1.15km) and the constraints mentioned above. This order of cost would be difficult for a developer to fund entirely and would probably require a combination of a significantly larger scale of development (potentially a few thousand dwellings) together with external funding assistance. Providing a new link road is therefore likely to prove technically very challenging and prohibitively expensive.

9.4.4 To model the attractiveness of a new link road for Ordsall South development traffic, the VISUM model described in **Chapter 8** has been updated to include a link between Ollerton Road and the A638. The link has been modelled as a single carriageway road with a 40mph speed limit. **Table 20** shows Ordsall South development flows that would be attracted to use a new link.

Table 20 – Ordsall South Development Flows using a New Link

Number of Dwellings	Peak Period	Eastbound	Westbound	2-Way
930	AM	234	86	320
	PM	95	214	309
1,250	AM	318	114	432
	PM	127	291	418

9.4.5 The VISUM model indicates that a new link would attract Ordsall South development trips from existing routes including, High Street / Goosemoor Lane, Main Road and Ordsall Road.

9.4.6 Based on the scale of development assessed in this TA and the likely number of development trips that would use a new link, the costs to deliver a new link would far outweigh the benefits and provision of a link road would therefore not satisfy the requirements of item 122(2) of The Community Infrastructure Levy Regulations 2010 which requires planning obligations to be necessary to make the development acceptable in planning terms; directly related to the development; and fairly and reasonably related in scale and kind to the development.

9.4.7 A link road would also only help to address traffic impacts associated with development traffic using roads local to the site and would provide no relief for development trips through Retford. At some locations in Retford town centre it will be very difficult to deliver any meaningful mitigation in the form of increased junction capacity due to the physical space constraints that exist within the urban environment.

10 JUNCTION CAPACITY ASSESSMENTS

10.1 INTRODUCTION

10.1.1 Capacity assessment have been undertaken at all junctions identified in **Table 19** with a red asterisk. Capacity assessments have been undertaken at off-site junctions for the following scenarios:

- 2021 base
- 2021 base + committed developments
- 2038 base + committed developments
- 2038 base + committed developments + Ordsall development
- 2038 base + committed developments + Ordsall development + other Local Plan allocation sites

10.1.2 Capacity assessments have been undertaken at the Ordsall South site access roundabouts for the following scenarios:

- 2038 base + committed developments + Ordsall development
- 2038 base + committed developments + Ordsall development + other Local Plan allocation sites

10.1.3 The Ordsall South development has been assessed based on 930 dwellings and a sensitivity test of 1,250 dwellings.

10.1.4 Capacity assessments undertaken at the Ordsall South site access roundabouts have been assessed on the basis that all development trips access the site from both roundabouts (i.e. development trips have not been split across the roundabouts). This provides a very robust assessment of the site access roundabouts. In the absence of a .dwg file of the site access roundabouts designed by the site promoter, assumptions have been made regarding the roundabout geometry for input to the site access capacity assessments.

10.1.5 Assessments of priority junctions and roundabouts have been undertaken using the Junctions 9 computer programme, which is the 'industry standard' traffic modelling computer software package used for assessing the capacity of priority junctions and roundabouts. Assessments of signal-controlled junctions have been undertaken using the LinSIG computer programme, which is the 'industry standard' traffic modelling software package used for assessing the capacity of signal-controlled junctions.

10.1.6 A Ratio of Flow to Capacity (RFC) value below 0.85 indicates that a junction operates 'within' capacity. An RFC value between 0.85 and 1.00 indicates that there may be occasions during the period modelled when queues will develop, and delays occur. An RFC value greater than 1.00 indicates that a junction operates 'above' capacity.

10.1.7 At signal-controlled junctions a Reserve Capacity (RC) or degree of overload is used to indicate whether a junction operates 'within' its theoretical capacity. The RC is the percentage of all round traffic growth, which a junction can accommodate within its capacity. When there is no RC, a degree of overload is the percentage by which the traffic flows exceed the capacity of the junction. Experience with RC calculations at existing junctions indicates that queuing does not become particularly noticeable until the degree of overload reaches 10% (i.e. -11% RC). For the purposes of comparison with priority junctions and roundabouts, it can be assumed that a RC of 0% (and a Degree of Saturation of 90%) roughly equates to an RFC of 0.85.

10.1.8 Geometry plans and capacity assessment outputs are presented in **Appendix K**. Geometry inputs have been updated to reflect previous feedback provided by NCC, where appropriate. In particular, it is worth noting that the western roundabout of the dumbbell arrangement at the A1/ A614 Blyth Road/ A57 Worksop Road has been modelled with a reduced entry width on the western approach (A57) to reflect uneven lane usage (the majority of traffic uses the offside lane).

10.2 CAPACITY ASSESSMENT RESULTS

10.2.1 A summary of the capacity assessment results is presented in **Table 21** on the next page and full outputs are presented in **Appendix K**.

Table 21 - Capacity Assessment Results (Ordsall South Assessed With 930 Dwellings)

Junction	Arm	2021 Base + Committed Developments				2038 Base + Committed Developments				2038 Base + Committed Developments + Ordsall Development				2038 Base + Committed Developments + Ordsall Development + Other Local Plan Sites			
		AM		PM		AM		PM		AM		PM		AM		PM	
		RFC	MMQ	RFC	MMQ	RFC	MMQ	RFC	MMQ	RFC	MMQ	RFC	MMQ	RFC	MMQ	RFC	MMQ
1A - A1 / B6079 Retford Road	B - A1 slip road	0.12	0.1	0.12	0.1	0.15	0.2	0.15	0.2	0.15	0.2	0.15	0.2	0.15	0.2	0.15	0.2
	C - B6079 Retford Road	0.20	0.4	0.22	0.5	0.25	0.6	0.28	0.7	0.37	0.9	0.33	0.8	0.37	1.0	0.34	0.8
1B - A1 / A620 Retford Road	B - A1 slip road	0.31	0.4	0.20	0.2	0.38	0.6	0.25	0.3	0.45	0.8	0.38	0.6	0.45	0.8	0.39	0.6
	C - B6079 Retford Road	0.00	0.0	0.02	0.0	0.00	0.0	0.02	0.0	0.00	0.0	0.03	0.0	0.00	0.0	0.03	0.0
2A - Apleyhead Interchange (A57 /Blyth Road / A1)	A - A57	0.61	1.6	0.59	1.4	0.74	2.8	0.71	2.3	0.75	3.0	0.73	2.6	0.81	4.0	0.88	6.7
	C - Road Access A1 (East)	0.46	0.8	0.42	0.7	0.54	1.1	0.49	1.0	0.57	1.3	0.50	1.0	0.73	2.6	0.53	1.1
	D - Slip Rd - Entry Only	0.39	0.6	0.45	0.8	0.48	0.9	0.55	1.2	0.49	1.0	0.55	1.2	0.61	1.5	0.57	1.3
	E – Blyth Road	0.33	0.5	0.30	0.4	0.40	0.7	0.36	0.6	0.41	0.7	0.38	0.6	0.53	1.1	0.42	0.7
2BA - A1 / B6420 Mansfield Road / A614 Blyth Road / A57	A- A57 S	0.84	4.6	0.77	3.0	1.02	20.1	0.94	9.6	1.03	21.2	0.95	10.8	1.22	68.4	1.04	22.0
	A1 Link	0.00	0.0	0.00	0.0	0.00	0.0	0.00	0.0	0.00	0.0	0.00	0.0	0.00	0.0	0.00	0.0
	A57 N	0.00	0.0	0.00	0.0	0.00	0.0	0.00	0.0	0.00	0.0	0.00	0.0	0.00	0.0	0.00	0.0
2BB - A1 / B6420 Mansfield Road / A614 Blyth Road / A57	Mansfield Road	0.48	0.9	0.43	0.7	0.60	1.5	0.52	1.1	0.70	2.3	0.56	1.3	1.04	22.4	0.64	1.7
	A57	0.00	0.0	0.00	0.0	0.00	0.0	0.00	0.0	0.00	0.0	0.00	0.0	0.00	0.0	0.00	0.0
3 - A1 / Elkesley Bridge Road	A - Poulter Rise	0.04	0.0	0.08	0.1	0.05	0.1	0.09	0.1	0.08	0.1	0.10	0.1	0.08	0.1	0.10	0.1
	B - Unamed Road	0.04	0.0	0.03	0.0	0.04	0.0	0.04	0.0	0.04	0.0	0.04	0.0	0.04	0.0	0.04	0.0
	C - Elkesley Bridge Rd	0.06	0.1	0.07	0.1	0.07	0.1	0.08	0.1	0.09	0.1	0.12	0.1	0.09	0.1	0.12	0.1
3B - Jockey Lane / Eskil Way	A- Poulter Rise SE	0.05	0.1	0.03	0.0	0.06	0.1	0.04	0.0	0.07	0.1	0.07	0.1	0.07	0.1	0.07	0.1
	B - Jockey Lane	0.05	0.0	0.06	0.1	0.05	0.1	0.07	0.1	0.09	0.1	0.08	0.1	0.09	0.1	0.08	0.1

Junction	Arm	2021 Base + Committed Developments				2038 Base + Committed Developments				2038 Base + Committed Developments + Ordsall Development				2038 Base + Committed Developments + Ordsall Development + Other Local Plan Sites			
		AM		PM		AM		PM		AM		PM		AM		PM	
		RFC	MMQ	RFC	MMQ	RFC	MMQ	RFC	MMQ	RFC	MMQ	RFC	MMQ	RFC	MMQ	RFC	MMQ
5A - Markham Moor Interchange (A638 / A57 Cliff gate / A57 / A1)	A - A57	0.20	0.3	0.24	0.3	0.24	0.3	0.28	0.4	0.25	0.3	0.32	0.5	0.26	0.4	0.34	0.5
	B - Entry Only	0.39	0.6	0.44	0.8	0.47	0.9	0.53	1.1	0.47	0.9	0.54	1.2	0.47	0.9	0.55	1.2
	C - A638	0.28	0.4	0.25	0.3	0.34	0.5	0.30	0.4	0.39	0.6	0.32	0.5	0.43	0.7	0.33	0.5
	D - Cliffe Gate	0.39	0.7	0.37	0.6	0.48	0.9	0.45	0.8	0.49	1.0	0.46	0.8	0.50	1.0	0.46	0.9
5B - A1 Markham Moor (A1 / Great N Road / Main Street / A57)	B - Entry from A1	0.13	0.2	0.18	0.2	0.16	0.2	0.22	0.3	0.17	0.2	0.24	0.3	0.17	0.2	0.24	0.3
	C - Great North Rd	0.21	0.3	0.21	0.3	0.26	0.3	0.26	0.4	0.27	0.4	0.31	0.5	0.29	0.4	0.35	0.5
	D - A638	0.19	0.2	0.19	0.2	0.23	0.3	0.24	0.3	0.24	0.3	0.25	0.3	0.24	0.3	0.25	0.3
	A - Cliffe Gate	0.36	0.6	0.40	0.7	0.42	0.7	0.48	0.9	0.42	0.7	0.49	0.9	0.42	0.7	0.50	1.0
6 - A620 Babworth Road / B6420 Mansfield Road / A620 Straight Mile / Sutton Lane	B - Mansfield Road	1.04	26.7	1.55	290.7	Max	539.9	Max	954.0	Max	739.4	Max	1183.0	Max	967.6	Max	1230.6
	B - Mansfield Road	1.02	1.7	0.14	6.5	Max	9.4	Max	20.0	Max	11.7	Max	23.3	Max	12.4	Max	23.6
	A - Babworth Road	0.81	4.8	0.62	1.8	0.83	5.1	0.63	1.8	0.83	5.1	0.63	1.9	0.76	3.5	0.64	1.9
	D - Sutton Lane	1.42	112.5	1.66	188.3	Max	63.8	Max	675.3	Max	629.1	Max	840.7	Max	665.6	Max	691.3
	D - Sutton Lane	1.03	1.5	1.30	2.2	Max	3.3	Max	6.2	Max	5.1	Max	6.7	Max	27.5	Max	12.2
	C - Straight Mile	0.95	12.5	0.95	12.8	0.95	12.9	0.95	12.0	0.95	12.0	0.97	1.3	0.95	10.9	0.98	12.4
7 - A620 Babworth Road / Ordsall Road	A- A620 Babworth Rd (E)	0.98	14.6	0.82	4.2	1.14	63.00	0.97	14.6	1.20	85.6	1.13	57.2	1.42	220.0	1.18	76.5
	B - Ordsall Road	0.94	8.5	0.60	1.5	1.13	34.90	0.76	2.9	1.64	225.0	0.91	7.2	1.70	264.1	0.98	13.0
	C - A620 Babworth Rd (W)	1.03	28.8	0.79	3.5	1.21	102.60	0.93	9.7	1.27	146.1	1.13	64.2	1.30	166.1	1.25	121.8
8 - A620 Amcott Way / Bridlegate / A620 Hospital Road / A638 North Road / Hallcroft Road	B - A620 Amcott Way	0.61	1.6	0.69	2.2	0.74	2.8	0.83	4.6	0.75	2.9	0.85	5.4	0.77	3.3	0.88	6.8
	C - Bridlegate	0.58	1.3	0.67	1.9	0.86	5.1	0.94	9.3	0.89	6.1	1.00	14.4	0.97	10.7	1.08	25.0
	D - A620 Hospital Road	0.89	6.7	0.84	5.0	1.15	64.8	1.07	39.8	1.21	91.0	1.09	48.3	1.25	104.0	1.16	75.5
	E - North Road	0.76	3.1	0.91	8.3	0.88	6.8	1.00	56.8	0.89	7.4	1.09	59.4	0.95	13.3	1.11	70.0
	A - Hallcroft Road	0.66	1.9	0.66	1.9	0.86	5.1	0.84	4.4	0.88	6.0	0.90	6.8	0.96	10.7	0.91	7.1

Junction	Arm	2021 Base + Committed Developments				2038 Base + Committed Developments				2038 Base + Committed Developments + Ordsall Development				2038 Base + Committed Developments + Ordsall Development + Other Local Plan Sites			
		AM		PM		AM		PM		AM		PM		AM		PM	
		RFC	MMQ	RFC	MMQ	RFC	MMQ	RFC	MMQ	RFC	MMQ	RFC	MMQ	RFC	MMQ	RFC	MMQ
9 - A620 Amcott Way / A620 Moorgate / A638 Arlington Way	Moorgate (ahead/left)	97.2	28.1	83.8	15.1	112.4	95.1	97.1	27.6	113.4	99.4	98.7	30.9	115.0	108.0	99.5	32.9
	Amcott Way (ahead/right)	97.2	26.1	83.7	12.0	113.6	115.0	97.2	21.5	113.6	117.5	97.2	21.5	114.5	126.0	99.8	27.0
	Arlington Way (right/left)	93.7	12.2	83.8	10.6	108.6	41.0	96.4	18.6	108.6	40.8	98.7	22.2	115.8	60.6	99.2	23.5
	Practical Reserve Capacity (%)	-8.0		7.4		-26.2		-8.0		-26.2		-9.7		-28.6		-10.8	
10 - A638 Arlington Way / Spital Hill / Chapelgate	Arlington Way (left/ahead/right)	68.1	14.0	74.2	16.6	79.5	18.7	86.1%	22.4	79.5%	18.7	84.5%	21.7	81.5%	20.1	86.5%	23.0
	Spital Hill (right/left/ahead)	67.3	7.2	73.0	7.7	78.7	9.2	84.6%	10.1	78.7%	9.2	89.3%	11.1	82.8%	9.7	89.3%	11.1
	Arlington Way (ahead/right/left)	63.3	12.1	77.0	17.7	73.7	16.0	87.6%	25.5	75.8%	17.0	88.5%	25.2	78.5%	17.0	91.4%	28.0
	Chapelgate (left/ahead/right)	27.0	2.3	49.2	4.6	36.4	2.8	63.1%	5.8	42.2%	3.1	82.3%	7.6	45.8%	3.2	82.3%	7.6
	Practical Reserve Capacity (%)	32.1		16.9		13.2		0.9		13.2		0.7		8.7		-1.6	
11 - A638 Arlington Way / Grove Street	Arlington Way (left/ahead/right)	76.2	13.7	84.8	17.8	88.7	21.1	98.1	32.3	88.7	21.1	98.1	32.3	92.4	24.6	98.1	29.1
	Grove Street (right/left/ahead)	57.5	3.1	58.3	3.2	67.4	3.9	68.2	4.0	67.4	3.9	68.2	4.0	67.4	3.9	68.2	3.8
	Arlington Way (ahead/right/left)	100.1	36.9	111.3	77.9	116.7	105.4	129.0	157.4	118.8	115.4	129.9	161.7	121.0	125.5	133.0	176.3
	Grove Street (left/ahead/right)	85.3	6.2	106.8	24.6	99.7	12.5	125.0	58.9	99.7	12.5	125.0	58.9	103.7	16.7	134.2	71.8
	Practical Reserve Capacity (%)	-11.2		-23.6		-29.7		-43.3		-32.0		-44.4		-34.4		-49.1	
12 - A638 Arlington Way / A638 London Road / Carolgate	Carolgate (left/ahead/right)	52.9	2.9	95.7	15.4	62.2	4.0	115.1	58.1	70.0	4.7	121.0	78.2	70.0	4.5	123.7	83.9
	Arlington Way (right/left/ahead)	40.8	6.1	62.6	11.9	47.2	7.5	70.8	15.9	47.7	7.6	73.7	16.6	51.0	8.5	75.1	17.9
	London Road (ahead/right/left)	86.6	17.6	97.6	23.9	102.2	44.8	113.8	80.3	106.6	63.7	119.7	102.7	109.0	77.5	124.3	122.4
	Albert Road (left/ahead/right)	86.1	8.6	93.3	10.3	103.0	19.7	113.0	32.1	103.7	20.4	115.7	34.5	107.7	27.7	119.0	38.9
	Practical Reserve Capacity (%)	3.9		-8.4		-14.5		-27.9		-18.5		-34.4		-21.1		-38.1	
13 - Ollerton Road / W Hill Road	B - Ollerton Road	0.07	0.1	0.10	0.1	0.08	0.1	0.12	0.1	0.15	0.2	0.33	0.5	0.15	0.2	0.33	0.5
	B - Ollerton Road	0.13	0.1	0.19	0.2	0.15	0.2	0.23	0.3	0.20	0.2	0.31	0.4	0.20	0.2	0.31	0.4
	C - West Hill Road	0.09	0.1	0.09	0.1	0.10	0.1	0.11	0.2	0.40	1.0	0.24	0.4	0.40	1.0	0.24	0.4

Junction	Arm	2021 Base + Committed Developments				2038 Base + Committed Developments				2038 Base + Committed Developments + Ordsall Development				2038 Base + Committed Developments + Ordsall Development + Other Local Plan Sites			
		AM		PM		AM		PM		AM		PM		AM		PM	
		RFC	MMQ	RFC	MMQ	RFC	MMQ	RFC	MMQ	RFC	MMQ	RFC	MMQ	RFC	MMQ	RFC	MMQ
14 - London Road / Whitehouses Road	A - A638 London Road (South)	0.69	2.2	1.09	51.0	0.81	4.2	1.30	156.1	0.85	5.1	1.42	224.4	0.87	6.2	1.47	265.6
	B - Whitehouses Road	0.96	11.0	0.89	5.9	1.23	59.5	1.01	15.5	1.50	146.2	1.05	23.9	1.55	158.7	1.08	29.4
	C A638 London Road	0.23	0.3	0.57	1.3	0.26	0.4	0.67	2.0	0.66	1.9	0.73	2.6	0.69	2.2	0.75	2.9
15 - London Road / Whinney Moor Lane / Bracken Lane	B - Bracken Lane	0.07	0.1	0.05	0.1	0.09	0.1	0.07	0.1	0.10	0.1	0.08	0.1	0.10	0.1	0.09	0.1
	B - Bracken Lane	0.14	0.2	0.11	0.1	0.20	0.2	0.17	0.2	0.22	0.3	0.21	0.3	0.24	0.3	0.24	0.3
	A - London Road (north)	0.11	0.1	0.15	0.2	0.13	0.2	0.19	0.2	0.14	0.2	0.19	0.2	0.14	0.2	0.20	0.2
	D - Whinney Moor Lane	0.20	0.3	0.16	0.2	0.34	0.5	0.40	0.6	0.47	0.9	1.03	5.2	0.57	1.2	1.15	7.1
	D - Whinney Moor Lane	0.38	0.6	0.49	0.9	0.57	1.3	0.77	2.7	0.70	2.1	1.02	8.0	0.76	2.6	1.13	11.8
	C - London Road (south)	0.05	0.0	0.05	0.1	0.06	0.1	0.07	0.1	0.06	0.1	0.07	0.1	0.06	0.1	0.07	0.1
16 - All Hallows Street / High Street / Goosemoor Lane	B - Goosemoor Lane	0.15	0.2	0.27	0.4	0.20	0.2	0.34	0.5	0.33	0.5	0.61	1.5	0.34	0.5	0.63	1.6
	B - Goosemoor Lane	0.47	0.9	0.46	0.8	0.57	1.3	0.56	1.3	0.64	1.7	0.62	1.6	0.67	1.9	0.64	1.7
	C - High Street	0.28	0.4	0.16	0.2	0.34	0.5	0.19	0.2	0.57	1.3	0.28	0.4	0.57	1.3	0.28	0.4
17 - Ollerton Road/Site Access (northern)	A - Ollerton Road (north)	-	-	-	-	-	-	-	-	0.24	0.3	0.44	0.8	0.24	0.3	0.44	0.8
	B - Site Access (east)	-	-	-	-	-	-	-	-	0.10	0.1	0.04	0.0	0.10	0.1	0.04	0.0
	C - Ollerton Road (south)	-	-	-	-	-	-	-	-	0.21	0.3	0.27	0.4	0.21	0.3	0.27	0.4
	D - Site Access (west)	-	-	-	-	-	-	-	-	0.32	0.5	0.13	0.1	0.32	0.5	0.13	0.1
17 - Ollerton Road/Site Access (southern)	A - Ollerton Road (north)	-	-	-	-	-	-	-	-	0.23	0.3	0.41	0.7	0.23	0.3	0.41	0.7
	C - Ollerton Road (south)	-	-	-	-	-	-	-	-	0.19	0.2	0.24	0.3	0.19	0.2	0.24	0.3
	D - Site Access (west)	-	-	-	-	-	-	-	-	0.29	0.4	0.12	0.1	0.29	0.4	0.12	0.1
18 - Ollerton Road / Brick Yard Road	B - Main Road	0.02	0.0	0.02	0.0	0.02	0.0	0.02	0.0	0.02	0.0	0.03	0.0	0.02	0.0	0.03	0.0
	B - Main Road	0.06	0.1	0.12	0.1	0.07	0.1	0.14	0.2	0.10	0.1	0.22	0.3	0.10	0.1	0.22	0.3
	C - Brick Yard Lane	0.03	0.0	0.01	0.0	0.03	0.0	0.01	0.0	0.03	0.0	0.01	0.0	0.03	0.0	0.01	0.0

Junction	Arm	2021 Base + Committed Developments				2038 Base + Committed Developments				2038 Base + Committed Developments + Ordsall Development				2038 Base + Committed Developments + Ordsall Development + Other Local Plan Sites			
		AM		PM		AM		PM		AM		PM		AM		PM	
		RFC	MMQ	RFC	MMQ	RFC	MMQ	RFC	MMQ	RFC	MMQ	RFC	MMQ	RFC	MMQ	RFC	MMQ
19 - A638 / Main Road	B - Main Road	0.05	0.1	0.04	0.0	0.07	0.1	0.05	0.1	0.07	0.1	0.05	0.1	0.07	0.1	0.05	0.1
	B - Main Road	0.13	0.1	0.11	0.1	0.17	0.2	0.15	0.2	0.32	0.5	0.23	0.3	0.34	0.5	0.24	0.3
	C - A638 (north)	0.04	0.1	0.06	0.1	0.05	0.1	0.08	0.1	0.05	0.1	0.08	0.2	0.06	1.0	0.09	0.2
20 - A638 / B6387 Rectory Lane	B - B6387 Rectory Lane	0.24	0.3	0.34	0.5	0.44	0.8	0.41	0.7	0.30	0.4	0.44	0.8	0.30	0.4	0.46	0.8
	C - A638 (south)	0.24	0.3	0.22	0.3	0.29	0.4	0.27	0.4	0.32	0.5	0.28	0.4	0.32	0.5	0.29	0.4

Table 22 - Capacity Assessment Results (Ordsall South Assessed With 1,250 Dwellings)

Junction	Arm	2038 Base + Committed Developments + Ordsall Development				2038 Base + Committed Developments + Ordsall Development + Other Local Plan Sites			
		AM		PM		AM		PM	
		RFC	MMQ	RFC	MMQ	RFC	MMQ	RFC	MMQ
1A - A1 / B6079 Retford Road	B - A1 slip road	0.15	0.2	0.15	0.2	0.15	0.2	0.15	0.2
	C - B6079 Retford Road	0.41	1.1	0.35	0.9	0.41	1.1	0.35	0.9
1B - A1 / A620 Retford Road	B - A1 slip road	0.48	0.9	0.43	0.7	0.48	0.9	0.43	0.8
	C - B6079 Retford Road	0.00	0.0	0.03	0.0	0.00	0.0	0.03	0.0
2A - Apleyhead Interchange (A57 /Blyth Road / A1)	A - A57	0.76	3.0	0.74	2.7	0.81	4.1	0.88	6.8
	C - Road Access A1 (East)	0.58	1.4	0.51	1.0	0.74	2.8	0.54	1.1
	D - Slip Rd - Entry Only	0.50	1.0	0.55	1.2	0.61	1.5	0.57	1.3
	E - BlythRoad	0.42	0.7	0.39	0.6	0.54	1.2	0.42	0.7
2BA - A1 / B6420 Mansfield Road / A614 Blyth Road / A57	A- A57 S	1.03	21.6	0.99	14.4	1.22	69.0	1.04	23.0
	A1 Link	0.00	0.0	0.00	0.0	0.00	0.0	0.00	0.0
	A57 N	0.00	0.0	0.00	0.0	0.00	0.0	0.00	0.0
2BB - A1 / B6420 Mansfield Road / A614 Blyth Road / A57	Mansfield Road	0.74	2.7	0.58	1.3	1.08	29.6	0.66	1.8
	A57	0.00	0.0	0.00	0.0	0.00	0.0	0.00	0.0
3 - A1 / Elkesley Bridge Road	A - Poulter Rise	0.09	0.1	0.11	0.1	0.09	0.1	0.11	0.1
	B - Unamed Road	0.04	0.0	0.04	0.0	0.04	0.0	0.04	0.0
	C - Elkesley Bridge Rd	0.09	0.1	0.13	0.1	0.09	0.1	0.13	0.1
3B - Jockey Lane / Eskil Way	A- Poulter Rise SE	0.08	0.1	0.09	0.1	0.08	0.1	0.09	0.1
	B - Jockey Lane	0.11	0.1	0.09	0.1	0.11	0.1	0.09	0.1
5A - Markham Moor Interchange (A638 / A57 Cliff gate / A57 / A1)	A - A57	0.26	0.3	0.33	0.5	0.27	0.4	0.35	0.5
	B - Entry Only	0.47	0.9	0.55	1.2	0.47	0.9	0.56	1.2
	C - A638	0.41	0.7	0.33	0.5	0.44	0.8	0.34	0.5
	D - Cliffe Gate	0.49	1.0	0.46	0.9	0.50	1.0	0.47	0.9
5B - A1 Markham Moor (A1 / Great N Road / Main Street / A57)	B - Entry from A1	0.17	0.2	0.25	0.3	0.17	0.2	0.25	0.3
	C - Great North Rd	0.28	0.4	0.33	0.5	0.29	0.4	0.37	0.6
	D - A638	0.24	0.3	0.25	0.3	0.24	0.3	0.26	0.3
	A - Cliffe Gate	0.42	0.7	0.49	1.0	0.42	0.7	0.50	1.0

Junction	Arm	2038 Base + Committed Developments + Ordsall Development				2038 Base + Committed Developments + Ordsall Development + Other Local Plan Sites			
		AM		PM		AM		PM	
		RFC	MMQ	RFC	MMQ	RFC	MMQ	RFC	MMQ
6 - A620 Babworth Road / B6420 Mansfield Road / A620 Straight Mile / Sutton Lane	B - Mansfield Road	Max	870.30	Max	1216.6	Max	1058.3	Max	1282.8
	B - Mansfield Road	Max	12.10	Max	23.5	Max	12.9	Max	24.1
	A - Babworth Road	0.83	5.2	0.64	1.9	0.76	3.6	0.64	2.0
	D - Sutton Lane	Max	661.20	Max	973.3	Max	767.4	Max	1014.4
	D - Sutton Lane	Max	5.20	Max	7.3	Max	31.2	Max	12.3
	C - Straight Mile	0.95	12.1	0.98	12.1	0.96	11.0	0.98	12.6
7 - A620 Babworth Road / Ordsall Road	A - A620 Babworth Rd (E)	1.22	94.1	1.18	75.4	1.44	233.1	1.23	97.3
	B - Ordsall Road	1.80	313.7	0.95	10.3	1.87	355.4	1.03	19.0
	C - A620 Babworth Rd (W)	1.29	162.0	1.20	95.2	1.32	182.5	1.32	170.9
8 - A620 Amcott Way / Bridlegate / A620 Hospital Road / A638 North Road / Hallcroft Road	B - A620 Amcott Way	0.75	3.0	0.86	5.8	0.78	3.7	0.89	7.3
	C - Bridlegate	0.90	6.6	1.02	16.7	0.99	11.6	1.10	28.4
	D - A620 Hospital Road	1.24	100.8	1.10	51.2	1.27	113.8	1.16	78.3
	E - North Road	0.90	7.7	1.09	60.3	0.95	13.8	1.11	70.8
	A - Hallcroft Road	0.89	6.3	0.92	8.1	0.96	11.5	0.93	8.5
9 - A620 Amcott Way / A620 Moorgate / A638 Arlington Way	Moorgate (ahead/left)	112.5	96.0	98.5	31.0	115.5	110.1	100.4	36.3
	Amcott Way (ahead/right)	113.6	117.2	99.2	25.2	114.5	126.5	99.8	27.0
	Arlington Way (right/left)	223.7	54.2	98.7	22.2	115.8	60.6	99.2	23.5
	Practical Reserve Capacity (%)	-26.4		-10.2		-28.6		-11.6	
10 - A638 Arlington Way / Spital Hill / Chapelgate	Arlington Way (left/ahead/right)	79.5	18.7	84.5	21.7	81.5	20.1	86.5	23.0
	Spital Hill (right/left/ahead)	78.7	9.2	89.3	11.1	82.8	9.7	89.3	11.1
	Arlington Way (ahead/right/left)	78.5	17.2	88.8	25.4	78.5	17.2	91.7	28.5
	Chapelgate (left/ahead/right)	44.1	3.2	87.4	8.6	48.0	3.3	87.4	8.6
	Practical Reserve Capacity (%)	13.2		0.7		8.7		-1.9	
11 - A638 Arlington Way / Grove Street	Arlington Way (left/ahead/right)	88.7	21.1	98.1	32.2	92.4	24.6	98.1	29.1
	Grove Street (right/left/ahead)	67.4	3.9	68.2	4.0	67.4	3.9	68.2	3.8
	Arlington Way (ahead/right/left)	119.4	118.3	130.2	162.9	121.6	128.5	133.3	177.5
	Grove Street (left/ahead/right)	99.7	12.5	125.0	58.9	103.7	16.7	134.2	71.8
	Practical Reserve Capacity (%)	-32.7		-44.6		-35.1		-49.1	
12 - A638 Arlington Way / A638 London Road / Carolgate	Carolgate (left/ahead/right)	73.0	5.0	122.2	83.6	73.0	4.8	124.9	88.9
	Arlington Way (right/left/ahead)	47.9	7.6	75.0	16.9	51.2	8.5	76.4	18.6
	London Road (ahead/right/left)	108.2	71.5	122.3	112.2	110.6	85.9	124.9	126.3
	Albert Road (left/ahead/right)	103.9	20.7	116.5	35.3	107.9	28.0	126.0	45.4
	Practical Reserve Capacity (%)	-20.2		-35.9		-22.9		-40.0	

Junction	Arm	2038 Base + Committed Developments + Ordsall Development				2038 Base + Committed Developments + Ordsall Development + Other Local Plan Sites			
		AM		PM		AM		PM	
		RFC	MMQ	RFC	MMQ	RFC	MMQ	RFC	MMQ
13 - Ollerton Road / W Hill Road	B - Ollerton Road	0.18	0.2	0.42	0.7	0.18	0.2	0.42	0.7
	B - Ollerton Road	0.22	0.3	0.35	0.5	0.22	0.3	0.35	0.5
	C - West Hill Road	0.53	1.7	0.29	0.6	0.53	1.7	0.29	0.6
14 - London Road / Whitehouses Road	A - A638 London Road (South)	0.86	5.4	1.46	249.0	0.89	6.8	1.51	290.9
	B - Whitehouses Road	1.60	184.7	1.07	28.2	1.64	197.7	1.12	39.7
	C A638 London Road	0.67	2.0	0.75	2.9	0.70	2.3	0.76	3.2
15 - London Road / Whinney Moor Lane / Bracken Lane	B - Bracken Lane	0.10	0.1	0.08	0.1	0.11	0.1	0.09	0.1
	B - Bracken Lane	0.23	0.3	0.23	0.3	0.25	0.3	0.26	0.3
	A - London Road (north)	0.15	0.2	0.19	0.2	0.15	0.2	0.20	0.2
	D - Whinney Moor Lane	0.57	1.2	1.12	6.7	0.74	2.2	1.26	8.9
	D - Whinney Moor Lane	0.76	2.6	1.11	11.4	0.84	3.5	1.24	16.2
	C - London Road (south)	0.06	0.1	0.07	0.1	0.06	0.1	0.07	0.1
16 - All Hallows Street / High Street / Goosemoor Lane	B - Goosemoor Lane	0.38	0.6	0.74	2.6	0.40	0.7	0.75	2.8
	B - Goosemoor Lane	0.68	2.0	0.71	2.3	0.70	2.2	0.73	2.5
	C - High Street	0.64	1.8	0.31	0.5	0.65	1.8	0.32	0.5
17 - Ollerton Road/Site Access (northern)	A - Ollerton Road (north)	0.28	0.4	0.54	1.2	0.28	0.4	0.54	1.2
	B - Site Access (east)	0.14	0.2	0.06	0.1	0.14	0.2	0.06	0.1
	C - Ollerton Road (south)	0.23	0.3	0.31	0.4	0.23	0.3	0.31	0.4
	D - Site Access (west)	0.44	0.8	0.17	0.2	0.44	0.8	0.17	0.2
17 - Ollerton Road/Site Access (southern)	A - Ollerton Road (north)	0.27	0.4	0.49	1.0	0.27	0.4	0.49	1.0
	C - Ollerton Road (south)	0.20	0.3	0.27	0.4	0.20	0.3	0.27	0.4
	D - Site Access (west)	0.39	0.6	0.16	0.2	0.39	0.6	0.16	0.2
18 - Ollerton Road / Brick Yard Road	B - Main Road	0.02	0.0	0.03	0.0	0.02	0.0	0.03	0.0
	B - Main Road	0.11	0.1	0.25	0.3	0.11	0.1	0.25	0.3
	C - Brick Yard Lane	0.03	0.0	0.01	0.0	0.03	0.0	0.01	0.0
19 - A638 / Main Road	B - Main Road	0.08	0.1	0.05	0.1	0.08	0.1	0.06	0.1
	B - Main Road	0.38	0.6	0.25	0.3	0.40	0.6	0.27	0.4
	C - A638 (north)	0.05	0.1	0.08	0.2	0.06	0.1	0.09	0.2
20 - A638 / B6387 Rectory Lane	B - B6387 Rectory Lane	0.30	0.4	0.46	0.8	0.31	0.4	0.47	0.9
	C - A638 (south)	0.33	0.5	0.29	0.4	0.33	0.5	0.30	0.4

10.2.2 As demonstrated by the capacity assessment results in **Table 21** and **Table 22** the following junctions are shown to experience capacity issues in one or more scenario:

- Junction 2A - Apleyhead Interchange (A57 /Blyth Road / A1)
- Junction 6 - A620 Babworth Rd/B6420 Mansfield Rd/A620 Straight Mile/Sutton Lane
- Junction 7 - A620 Babworth Road/Ordsall Road
- Junction 8 - A620 Amcott Way/Bridlegate/A620 Hospital Rd/A638 North Road/Hallcroft Rd
- Junction 9 - A620 Amcott Way/A620 Moorgate/A638 Arlington Way
- Junction 11 - A638 Arlington Way/Grove Street
- Junction 12 - A638 Arlington Way/A638 London Road/Carolgate
- Junction 14 - A638 London Road/Whitehouses Road
- Junction 15 - London Road / Whinney Moor Lane / Bracken Lane

10.2.3 The Apleyhead Interchange is shown to operate above capacity in scenarios where trips associated with the other Local Plan allocation sites are included in the assessment. The approach from the A57 (west) is over-capacity in the PM peak by 2038 and is the only arm of the junction that is over capacity. The RFC value does not exceed 0.88 in any scenario.

10.2.4 The A620 / B6420 junction (Junction 6) is shown to operate within capacity in the 2021 base scenario only. The addition of development trips from Ordsall South and other Local Plan allocation sites results in worsening of junction performance on all approaches except Babworth Road.

10.2.5 The A620 Babworth Road/Ordsall Road junction (Junction 7) is shown to exceed capacity on all arms of the junction in the 2021 'base' scenario. Junction performance significantly worsens in 2038. In the '2038 base plus committed development plus Ordsall South plus other Local Plan allocation sites', the longest queue for a development of 930 dwellings at Ordsall South is shown to be circa 1.6km on the Ordsall Road arm in the AM peak hour, with large queues shown on all approaches in both peak periods.

10.2.6 The A620 Amcott Way/Bridlegate/A620 Hospital Road/A638 North Road/Hallcroft Road junction (Junction 8) is shown to operate within capacity in the 2021 base scenario. The addition of Ordsall South development trips and trips from other allocation sites worsens junction performance with all arms of the junction shown to be over-capacity in at least one scenario in 2038.

10.2.7 The A620 Amcott Way/A620 Moorgate/A638 Arlington Way junction (Junction 9) is shown to operate within capacity at 2021. In the 2038 scenarios assessing Ordsall South with 930 dwellings, the junction is shown to be over capacity in the AM scenario and also the PM scenario when other Local Plan allocation sites are included in the assessment. In the sensitivity test

assessing Ordsall South with 1,250 dwellings, the junction is shown to be over-capacity in the AM and PM scenarios at 2038.

- 10.2.8 The A638 Arlington Way/Grove Street junction (Junction 11) is shown to be over-capacity in both peaks in all scenarios. The only exception is the 2021 base scenario in which the junction is shown to be operating within capacity in the AM peak.
- 10.2.9 The A638 Arlington Way/A638 London Road/Carolgate junction (Junction 12) is shown to operate within capacity at 2021 in the 'base' and 'base plus committed developments' scenarios. At 2038 the junction is shown to be over-capacity in the AM and PM peak hours in all scenarios.
- 10.2.10 The A638 London Road/Whitehouses Road junction (Junction 14) is shown to operate above capacity on the A638 London Road (south) and Whitehouses Road arms of the junction in all scenarios except the 2021 AM base in which London Road (south) is shown to be within capacity in the 2021 AM base. The London Road (north) arm of the junction is shown to operate within capacity in all scenarios.
- 10.2.11 The London Road/Whinney Moor Lane/Bracken Lane junction (Junction 15) is shown to operate within capacity at 2021. With the addition of committed development trips and/or trips from other Local Plan sites, the capacity of the junction is exceeded at 2038. Capacity is exceeded on the Whinney Moor Lane arm of the junction in the 2038 scenarios. Capacity is not exceeded on other arms.
- 10.2.12 In addition to the junctions that have been identified above, it is noted that Junction 2B 'A1 / B6420 Mansfield Road / A614 Blyth Road / A57' is also shown to be over-capacity in some scenarios. Although the junction forms part of a dumbbell roundabout, it is not a conventional roundabout. As such, in this TA the junction has been modelled as two priority junctions. However, the junctions are not conventional priority junctions and modelling them as such may be impacting on the results presented. The modelling approach applied at this junction should be discussed and agreed with NCC when the TA is prepared as part of a planning application.

11 MITIGATION

11.1 INTRODUCTION

11.1.1 This Chapter outlines a preliminary strategy for mitigating the impact of a development of 930 dwellings (and a sensitivity test of 1,250 dwellings) at the Ordsall South site.

11.2 SUSTAINABLE TRAVEL INFRASTRUCTURE/MEASURES

11.2.1 Current best practice recommends that the transport implications of developments should be assessed having regard to:

- **Measures to encourage environmental sustainability** – i.e. reducing the need to travel, especially by car, providing sustainable transport information and choices and measures to assist in influencing travel behaviour.
- **Managing the existing network** – i.e. making best use of existing transport infrastructure, low cost improvements such as signal control systems and intelligent transport systems.
- **Mitigating residual impacts** – through demand management; improvements to public transport networks, walking and cycling infrastructure; and through minor physical improvements to existing roads.

11.2.2 In accordance with the NPPF all developments which generate significant amounts of movement will be required to provide a Travel Plan. As part of the travel planning process developers will be required to nominate a Travel Plan Coordinator and make financial contributions for the annual monitoring of travel plan performance against agreed targets for an agreed period following occupation of the development. In addition, bond payments will also be sought to cover the provision of supplementary sustainable travel infrastructure/measures if agreed targets are not met. Furthermore, if Travel Plan initiatives are relied on to address network capacity issues, fallback infrastructure improvements will need to be identified and secured as part of the planning application process if agreed targets are not met.

11.2.3 The detailed content of the Travel Plan will be site specific and will need to be agreed with the highway and planning authorities at the planning application stage but in general terms will set out the process for monitoring future travel behavior, and the site-specific strategy and measures that will be introduced to influence modal choice with a view to reducing dependency upon the private car. The broad aims of Travel Plan reports being to:

- Encourage the use of alternative modes of transport to the private car and to better manage private car usage to reduce environmental impacts for all journeys associated with the proposed development.

- Include 'smarter choices' (for example car sharing, car clubs, teleworking, teleconferencing, home shopping, electric vehicle infrastructure etc.) to help change the way people travel.
- Deliver long-term commitments to changing travel habits by minimising the percentage of single occupancy car journeys associated with the proposal and maximising the proportion of trips made by public transport, by car share, on foot and by cycle.
- Identify and achieve the support of stakeholders for the Travel Plan and encourage a sustainable transport culture, which will develop and grow with time.
- To educate residents and employees regarding the health benefits of walking and cycling.
- To seek to reduce traffic generated by development to a lower level of car trips than would occur without the implementation of a Travel Plan.
- Promote healthy lifestyles and vibrant communities.

11.2.4 The site developer will be required to fund measures and/or infrastructure improvements required to mitigate the direct transport impacts of the development. This will include funding for items such as Smarter Choices measures and initiatives, Travel Plan, on and off-site cycling and walking infrastructure, bus network/infrastructure enhancements and new/enhanced bus services, where these can be demonstrated to be financially self-supporting in the long term.

11.3 BUS TRANSPORT

11.3.1 As discussed earlier in this report the existing bus services stopping close to the site are not high frequency services. Enhancements to these services, or the provision of new complimentary services should therefore be provided by the developer to ensure that residents on the completed development have sustainable travel choices available to them that meet the aspirations of the National Bus Strategy and supporting documents. The layout of the site should also be configured to allow bus penetration into the western parcel of land, as a minimum.

11.3.2 Consultation with existing bus service providers is recommended to test the commerciality of (and therefore reduce the subsidy required for) any potential service improvements. Furthermore, the 'Bus Back Better: national bus strategy for England' (March 2021) as well as NCC's Bus Service Improvement Plan (BSIP) (Autumn 2021) and the intention to implement an Enhanced Partnership in 2022 should be acknowledged. Future bus service provision should be in accordance with the aspirations set out in the national bus strategy and BSIP.

11.3.3 Regarding timing, it is essential to implement new and improved bus services and infrastructure very early in the life of a development, ideally before any units on the site are occupied, so that facilities are available and operational for new residents to use immediately. This is an important aspect of establishing good, sustainable travel behaviour and should be a conditional requirement of planning permissions for new development.

- 11.3.4 Detailed investigations should be undertaken at the planning application stage in order to identify the appropriate level of new/improved bus services and complementary infrastructure improvements required in order to support the trip rates used in this TA, cater for forecast demands and achieve modal split targets. Delivery of an appropriate package of improvements should be a conditional requirement of planning permission and should be implemented prior to development occupation and expanded into the site as development progresses to encourage good, sustainable travel behaviour.
- 11.3.5 It should be noted that in spring 2021 Nottinghamshire County Council was successful with a £1.5m bid to the Department of Transport Rural Mobility Fund. This funding will be used to pilot flexible Demand Responsive Transport (DRT) services across Nottinghamshire using new route planning and booking software and new vehicles. The areas to be served in Bassetlaw will be based on a revised network of services in the Ollerton Area with a new hub for interchange to mainline services. The services are expected to commence in 2022.
- 11.3.6 It is also worth noting the potential that community transport and related services such as taxi buses could have in providing a more sustainable alternative to conventional bus services. Several community transport providers are based in Bassetlaw including Bassetlaw Action Centre, based in Retford, which offers community car and minibus schemes including wheelchair accessible transport.
- 11.3.7 Improvements to bus networks/infrastructure should be timed to coincide with development to meet forecast demand.
- 11.3.8 The cost of providing additional bus resources will depend on the service specifics identified at the planning application stage and will be dependent upon the details of the bus contract specifications, numbers of vehicles required, routes, service frequencies and any new/improved infrastructure required.
- 11.3.9 However, as a general 'rule of thumb' a new bus service with a single vehicle costs in the order of £475 to £500 per day to operate, or approximately £175,000 per vehicle per annum for a 7-day service.
- 11.3.10 Improvements are funded to a specified level for specific time periods and are not therefore "open-ended" (usually secured via a Section 106 Agreement). It is typically the case that developers would fund a bus service for a minimum of five years, subject to build-out / occupation rate. After five years the idea is that the service would be sustainable without the need for financial support. This would need to be explored in further detail. The risk is that if the service is not sustainable and additional support is not available, the bus service would cease to operate or would operate a reduced timetable.

11.3.11 Based on the assumption that a new service comprising two buses is required this would equate to a total cost of circa £1.75m for the service to be fully funded for a five year period, assuming no revenue generation from fares.

11.3.12 The bus service should be supported with high quality bus stop facilities within and adjacent the site meeting the standard set out in the Nottinghamshire County Council Highway Design guide and included as a conditional requirement of planning permissions for new development. This should include real time bus stop poles & displays with associated electrical connections, shelters, lighting, timetable cases and bus stop clearways. To future proof the development to allow the use of electric buses, the provision of vehicle charging infrastructure should be included.

11.4 CYCLING AND WALKING INFRASTRUCTURE

11.4.1 The site developer will be required to deliver new and improved walking and cycling infrastructure to connect the development to neighbouring areas and facilitate safe travel by these modes. A detailed access strategy will need to be identified at the planning application stage.

11.4.2 As advised by NCC, cycle infrastructure improvements should be carried out in accordance with Department for Transport (DfT) LTN 1/20 'Cycle Infrastructure Design'.

11.4.3 Where cycle infrastructure cannot meet the requirements of LTN 1/20, this should be discussed with NCC. NCC will be required to advise if the developer should provide cycle infrastructure that meets the requirements LTN as best it can but acknowledging that it will not be fully LTN 1/20 compliant, or alternatively, if cycle infrastructure should not be provided.

11.4.4 Subject to NCC approval in relation to LTN 1/20, as a minimum this should provide for LTN 1/20 compliant cycle infrastructure along Ollerton Road to connect the site to Ordsall as well as improvements to existing Public Rights of Way that cross the site and run along its boundaries.

11.4.5 Regarding timing, it is important to implement this new/improved walking and cycling infrastructure very early in the life of the development, ideally before any units on the site are occupied, so that the facilities are available and operational for new residents to use immediately. This is an important aspect of establishing good, sustainable travel behaviour and should be a conditional requirement of planning permissions for new development.

11.4.6 Indicative construction costs for developing new cycling and walking facilities are in the region of:

- New footway/ cycleway – £150,000 to £300,000 per km particularly dependent upon the number and complexity of side road junctions
- New on carriageway cycle lane – £25,000 to £50,000 per km depending upon number of junctions/ signalised junctions, existing highway layout, on street parking constraints etc.

- Rural/ off carriageway route – £50,000 to £100,000 per km primarily dependent upon surfacing material required
- Controlled crossing (toucan) in urban area – £60,000 per site (likely to be higher if on higher speed road or requires Pegasus arrangement to cater for equestrian use also)
- New pair of dropped (uncontrolled) crossings – £2,500 per site.

11.5 MITIGATION OF RESIDUAL HIGHWAY IMPACTS

11.5.1 The site developer will also be required to deliver off-site highway infrastructure improvements to mitigate residual traffic impacts. Details of which will need to be determined at the planning application stage through the submission of a Transport Assessment produced in accordance with the NPPF. The developer will be required to assess the transport implication of the site and the cumulative implications of any other committed land-use development and transport schemes in the local area. Appropriate transport mitigation will need to be identified and agreed with the highway authority to address residual traffic impacts. Delivery of mitigation will be secured through the planning approval process.

11.6 MITIGATION OVERVIEW

11.6.1 If junction modelling shows a junction to operate above capacity following the addition of development trips, NCC highways is likely to seek mitigation. If a junction is shown to operate above capacity prior to the introduction of development trips, the developer will be required to mitigate the impact of the development but will not be required to fix existing problems i.e. mitigation should be determined on a 'nil-detriment' basis.

11.6.2 At the nine junctions shown to be over-capacity, a preliminary approach to mitigation has been identified. Any scheme involving physical junction improvement works uses land within the adopted highway only.

11.7 APLEYHEAD INTERCHANGE (A57 /BLYTH ROAD / A1)

11.7.1 The layout of the existing junction is shown in the image below.



(Map data © Ordnance Survey)

- 11.7.2 The junction operates as a standard roundabout forming the western roundabout of a dumbbell layout. The junction includes slip roads to/from the northbound carriageway of the A1 as well providing access to the A57 and A614 Blyth Road.
- 11.7.3 To mitigate the impact of the development, the lane allocations for the A57 (west) approach have been amended to allow ahead moves from both lanes. The exit from the roundabout onto the bridge over the A1 has been widened to allow a two lane exit. A preliminary layout drawing is presented in **Appendix L** together with Junctions 9 model outputs. **Table 23** summarises the results of the '2038 Base + Committed Developments + Ordsall Development + Other Local Plan Developments' scenario for 930 dwellings at Ordsall South and demonstrates that the junction will operate within capacity. The table also summarises the results of the same scenario but for the Ordsall South 1,250 dwellings sensitivity test.

Table 23 – Capacity Assessment Results for Entry Widening Mitigation Scheme

Arm	2038 Base + Committed Developments + Ordsall South (930 dwellings) + Other Local Plan Developments			
	AM		PM	
	RFC	MMQ	RFC	MMQ
A57	0.57	1.3	0.69	2.2
Road Across A1	0.73	2.6	0.53	1.1
Slip road from Worksop Road	0.61	1.5	0.57	1.3
Blyth Road	0.53	1.1	0.42	0.7

Arm	2038 Base + Committed Developments + Ordsall South (1,250 dwellings) + Other Local Plan Developments			
	AM		PM	
	RFC	MMQ	RFC	MMQ
A57	0.57	1.3	0.70	2.3
Road Across A1	0.74	2.8	0.54	1.2
Slip road from Worksop Road	0.61	1.5	0.57	1.3
Blyth Road	0.54	1.2	0.42	0.7

11.7.4 As demonstrated by the capacity results in **Table 23**, the roundabout operates within capacity following introduction of the mitigation scheme.

11.8 A620 / B6420 MANSFIELD ROAD JUNCTION

11.8.1 The layout of the existing junction is shown in the image below.



(Map data © Ordnance Survey)

11.8.2 The junction currently operates as a staggered priority crossroad arrangement with right turn ghost islands provided on the A620. The junction also incorporates a private access to the north.

11.8.3 To mitigate the impact of the development, a signal-controlled junction has been assessed. A preliminary layout drawing is presented in **Appendix L** together with LinSIG model outputs. **Table 24** summarises the results of the ‘2038 Base + Committed Developments + Ordsall Development + Other Local Plan Developments’ scenario for 930 dwellings at Ordsall South and demonstrates that the junction will operate within capacity. The table also summarises the results of the same scenario but for the Ordsall South 1,250 dwellings sensitivity test.

Table 24 – Capacity Assessment Results for a Signal Controlled Mitigation Scheme

Arm	2038 Base + Committed Developments + Ordsall South (930 dwellings) + Other Local Plan Developments			
	AM		PM	
	DoS	MMQ	DoS	MMQ
A620 Babworth Road	87.9%	19.6	89.2%	18.0
B6420 Mansfield Road	87.1%	9.4	97.6%	17.7
A620 Straight Mile	76.8%	17.6	96.5%	30.7
Sutton Lane	17.9%	0.8	27.4%	1.3
Practical Reserve Capacity	2.4%		-8.4%	
Arm	2038 Base + Committed Developments + Ordsall South (1,250 dwellings) + Other Local Plan Developments			
	AM		PM	
	DoS	MMQ	DoS	MMQ
A620 Babworth Road	91.8%	24.6	92.0%	21.0
B6420 Mansfield Road	91.9%	11.1	99.5%	20.3
A620 Straight Mile	77.5%	18.2	101.7%	44.0
Sutton Lane	17.9%	0.8	27.4%	1.3
Practical Reserve Capacity	-2.1%		-13.0%	

11.8.4 A comparison of the results in **Table 21**, **Table 22** and **Table 24** demonstrates that the signal-controlled mitigation scheme fully mitigates the impact of Ordsall South and other Local Plan development.

11.9 A620 BABWORTH ROAD / ORDSALL ROAD

11.9.1 The layout of the existing junction is shown in the image below.



(Map data © 2021 TomTom)

11.9.2 This is one of the off-site junctions where the greatest increase in trips is forecast. The existing junction is a three-arm mini-roundabout.

11.9.3 To mitigate the impact of the development, a preliminary signal-controlled junction improvement has been assessed. A preliminary layout drawing is presented in **Appendix L** along with LinSIG model outputs. **Table 25** summarises the results of the '2038 Base + Committed Developments + Ordsall Development + Other Local Plan Developments' scenario for 930 dwellings at Ordsall South and demonstrates that the junction will operate within capacity. The table also summarises the results of the same scenario but for the Ordsall South 1,250 dwellings sensitivity test.

Table 25 – Capacity Assessment Results for a Signal Controlled Mitigation Scheme

Arm	2038 Base + Committed Developments + Ordsall South (930 dwellings) + Other Local Plan Developments			
	AM		PM	
	DoS	MMQ	DoS	MMQ
A620 Babworth Road (east)	96.4%	31.8	77.9%	16.4
Ordsall Road	95.8%	15.9	78.4%	6.7
Babworth Road (west)	96.0%	18.7	78.4%	10.5
Practical Reserve Capacity	-7.1%		14.9%	
Arm	2038 Base + Committed Developments + Ordsall South (1,250 dwellings) + Other Local Plan Developments			
	AM		PM	
	DoS	MMQ	DoS	MMQ
A620 Babworth Road (east)	99.9%	39.3	84.9%	18.9
Ordsall Road	100.2%	25.4	84.8%	7.9
Babworth Road (west)	98.7%	23.3	84.5%	11.8
Practical Reserve Capacity	-11.3%		6.1%	

11.9.4 A comparison of the results in **Table 21**, **Table 22** and **Table 25** demonstrates that the signal-controlled mitigation scheme fully mitigates the impact of Ordsall South and other Local Plan development.

11.10 A620 AMCOTT WAY / BRIDLEGATE / A620 HOSPITAL ROAD / A638 NORTH ROAD / HALLCROFT ROAD

11.10.1 The layout of the existing junction is shown in the image below.



(Map data © Ordnance Survey)

11.10.2 The existing junction is a 5-arm priority roundabout with existing residential development on all sides which constrains options for improvement. Demand management measures to influence development modal splits (i.e. increasing use of sustainable transport in order to reduce car trips) should therefore be fully explored to help reduce development traffic impacts at this junction. This should include consideration of contributions towards new/improved public transport infrastructure and services. As outlined later in this Chapter, demand management measures are put forward as an approach to mitigation at two other off-site junctions. Demand management measures at all three off-site junctions are discussed further in **Section 11.17**.

11.10.3 In the event that modal shift alone cannot address forecast impacts at this junction then the most likely form of improvement that could be delivered would be either the introduction of signal control on the roundabout or replacing the junction with a signal-controlled crossroads. However, both of these options would be very difficult to deliver in practice due to the constrained nature of the junction, so modal shift should be the initial priority. The site developers will be expected to deliver/fund any improvements required to achieve 'nil detriment'.

11.11 A620 AMCOTT WAY / A620 MOORGATE / A638 ARLINGTON WAY

11.11.1 The layout of the existing junction is shown in the image below.



(Map data © 2021 Ordnance Survey)

11.11.2 To mitigate the impact of the development, an improved signal-controlled junction has been assessed. A preliminary layout drawing is presented in **Appendix L** together with LinSIG model outputs. **Table 26** summarises the results of the '2038 Base + Committed Developments + Ordsall Development + Other Local Plan Developments' scenario for 930 dwellings at Ordsall South and demonstrates that the junction will operate within capacity. The table also summarises the results of the same scenario but for the Ordsall South 1,250 dwellings sensitivity test.

Table 26 – Capacity Assessment Results for a Signal Controlled Mitigation Scheme

Arm	2038 Base + Committed Developments + Ordsall South (930 dwellings) + Other Local Plan Developments			
	AM		PM	
	DoS	MMQ	DoS	MMQ
Moorgate (ahead/left)	104.3%	59.2	90.9%	19.8
Amcott Way (ahead/right)	106.0%	36.6	91.1%	17.0
Arlington Way (right/left)	105.4%	90.9	90.8%	19.9
Practical Reserve Capacity	-17.8%		-1.2%	
Arm	2038 Base + Committed Developments + Ordsall South (1,250 dwellings) + Other Local Plan Developments			
	AM		PM	
	DoS	MMQ	DoS	MMQ
Moorgate (ahead/left)	104.5%	60.3	91.4%	20.2
Amcott Way (ahead/right)	106.0%	36.6	91.1%	17.5
Arlington Way (right/left)	105.6%	92.5	90.8%	19.7
Practical Reserve Capacity	-17.8%		-1.6%	

11.11.3 A comparison of the results in **Table 21**, **Table 22** and **Table 26** demonstrates that the signal-controlled mitigation scheme fully mitigates the impact of Ordsall South and other Local Plan development.

11.12 A638 ARLINGTON WAY / GROVE STREET

11.12.1 The layout of the existing junction is shown in the image below.



(Map data © Ordnance Survey)

11.12.2 The existing junction is a 4-arm signal controlled junction with existing commercial/residential development on all sides which constrains options for improvement.

11.12.3 Demand management measures to influence development modal splits (i.e. increasing use of sustainable transport in order to reduce car trips) should therefore be fully explored to help reduce development traffic impacts at this junction. This should include consideration of contributions towards new/improved public transport infrastructure and services. Demand management measures are discussed further in **Section 11.17**.

11.12.4 The site developers will be expected to deliver/fund any improvements or demand management measures required to achieve 'nil detriment'.

11.13 A638 ARLINGTON WAY / A638 LONDON ROAD / CAROLGATE

11.13.1 The layout of the existing junction is shown in the image below.



(Map data © 2021 Google)

11.13.2 The existing junction is a 4-arm signal controlled junction with existing commercial/residential development on all sides which constrains options for improvement.

11.13.3 Demand management measures to influence development modal splits (i.e. increasing use of sustainable transport in order to reduce car trips) should therefore be fully explored to help reduce development traffic impacts at this junction. This should include consideration of contributions towards new/improved public transport infrastructure and services. Demand management measures are discussed further in **Section 11.17**.

11.13.4 The site developers will be expected to deliver/fund any improvements or demand management measures required to achieve 'nil detriment'.

11.14 LONDON ROAD / WHITEHOUSES ROAD

11.14.1 The existing three-arm mini-roundabout layout is shown in the image below.



(Map data © 2021 Google)

11.14.2 To mitigate the impact of the development, a preliminary signal-controlled junction improvement has been assessed. A preliminary layout drawing is presented in **Appendix L** along with LinSIG model outputs. **Table 27** summarises the results of the '2038 Base + Committed Developments + Ordsall Development + Other Local Plan Developments' scenario for 930 dwellings at Ordsall South and demonstrates that the junction will operate within capacity. The table also summarises the results of the same scenario but for the Ordsall South 1,250 dwellings sensitivity test.

Table 27 – Capacity Assessment Results for a Signal Controlled Mitigation Scheme

Arm	2038 Base + Committed Developments + Ordsall South (930 dwellings) + Other Local Plan Developments			
	AM		PM	
	DoS	MMQ	DoS	MMQ
A638 London Road (south)	87.7%	18.6	117.3%	127.4
Whitehouses Road	87.9%	13.7	113.1%	40.5
A638 London Road (north)	85.3%	14.3	114.6%	89.7
Practical Reserve Capacity	2.3%		-30.3%	
Arm	2038 Base + Committed Developments + Ordsall South (1,250 dwellings) + Other Local Plan Developments			
	AM		PM	
	DoS	MMQ	DoS	MMQ
A638 London Road (south)	90.0%	19.8	119.0%	137.4
Whitehouses Road	90.8%	15.9	118.0%	50.7
A638 London Road (north)	89.6%	15.6	119.1%	116.5
Practical Reserve Capacity	-0.9%		-32.3%	

11.14.3 A comparison of the results in **Table 21**, **Table 22** and **Table 27** demonstrates that the signal-controlled mitigation scheme substantially mitigates the impact of Ordsall South and other Local Plan development. At the planning application stage the applicant will need to investigate the

operation of the proposed signal junction in greater detail to achieve the optimum performance, combined with travel demand measures to minimise off-site traffic impacts.

11.15 LONDON ROAD / WHINNEY MOOR LANE / BRACKEN LANE

11.15.1 The layout of the existing four-arm priority crossroad junction is shown in the image below.



(Map data © Ordnance Survey)

11.15.2 To mitigate the impact of development, consideration was given to widening on the Whinney Moor Lane approach. However, this did not mitigate the impact of Ordsall South and other Local Plan allocation sites. It is therefore likely that a signal-controlled scheme will be required at this location. A preliminary signal-controlled junction improvement has been assessed. A preliminary layout drawing is presented in **Appendix L** along with LinSIG model outputs. **Table 28** summarises the results of the '2038 Base + Committed Developments + Ordsall Development + Other Local Plan Developments' scenario for 930 dwellings at Ordsall South and demonstrates that the junction will operate within capacity. The table also summarises the results of the same scenario but for the Ordsall South 1,250 dwellings sensitivity test.

Table 28 – Capacity Assessment Results for a Signal Controlled Mitigation Scheme

Arm	2038 Base + Committed Developments + Ordsall South (930 dwellings) + Other Local Plan Developments			
	AM		PM	
	DoS	MMQ	DoS	MMQ
A - London Road (north)	60.9%	14.9	84.1%	27.4
B - Bracken Lane	45.4%	2.3	20.2%	1.2
C - London Road (south)	91.6%	34.4	88.2%	30.9
D - Whinney Moor Lane	90.5%	9.7	84.0%	8.0
Practical Reserve Capacity	-1.7%		2.1%	
Arm	2038 Base + Committed Developments + Ordsall South (1,250 dwellings) + Other Local Plan Developments			
	AM		PM	
	DoS	MMQ	DoS	MMQ
A - London Road (north)	65.1%	16.7	67.8%	30.5
B - Bracken Lane	45.0%	2.3	20.2%	1.2
C - London Road (south)	95.7%	40.8	92.5%	35.6
D - Whinney Moor Lane	91.4%	10.0	86.4%	8.5
Practical Reserve Capacity	-6.3%		-2.7%	

11.15.3 A comparison of the results in **Table 21**, **Table 22** and **Table 28** demonstrates that the signal-controlled mitigation scheme fully mitigates the impact of Ordsall South and other Local Plan development.

11.16 MAIN ROAD

11.16.1 As indicated previously in this report, NCC has expressed concern relating to any increase in traffic using Main Road. This is due to the character of Main Road which is a historic village layout with a winding road alignment, buildings directly abutting the carriageway, with poor forward and side-road visibility in places. Immediately to the west of the village, Main Road crosses the River Idle via a narrow bridge with no footways and a carriageway that is only wide enough for one-way traffic.

11.16.2 Whilst it may be possible to deliver improvements to the A638/Main Road junction and possibly introduce one-way traffic signal controlled working at the bridge it is unlikely to be appropriate to do so in practice because such improvements would only encourage more traffic to pass through the village.

11.16.3 The most likely form of mitigation is therefore the introduction of measures to discourage development-related traffic to drive between Ollerton Road and the A638 through the village. This could comprise a package of signing/lining measures and, if appropriate, traffic calming measures. Drawings showing an indicative traffic calming scheme for Main Road are presented in **Appendix L**. If appropriate, the developer should work with NCC to design a suitable mitigation scheme as part of the Transport Assessment to be submitted with a planning application.

11.17 DEMAND MANAGEMENT MEASURES

11.17.1 As indicated on the traffic flow diagrams in **Appendix J**, development at Ordsall South plus development of other Local Plan allocation sites will result in the increase in vehicle trips shown in **Table 29** at off-site junctions where demand management measures are identified as a mitigation measure.

Table 29 – Trip increases where Demand Management Mitigation Measures are Identified

Junction	Ordsall South (930 dwellings) + Other Local Plan Sites		Ordsall South (1,250 dwellings) + Other Local Plan Sites	
	AM Peak	PM Peak	AM Peak	PM Peak
A620 Amcott Way / Bridlegate / Hospital Road / North Road	195	195	222	222
A638 Arlington Way / Grove Street	71	64	77	66
A638 Arlington Way / A638 London Road / Carolgate	139	139	168	167

11.17.2 For demand management measures to achieve nil-detriment, a reduction in peak hour trips by the number of trips in **Table 29** will be required. A robust Travel Plan should be prepared to minimise the number of trips undertaken by single occupancy cars and maximise the number of trips undertaken by non-car modes. This should assist in reducing the increase in trips at off-site junctions. However, more extensive demand management measures will be required to achieve nil-detriment.

11.17.3 Improvements to bus services are considered the most likely demand management measure that could result in nil-detriment at the junctions in **Table 29**. Detailed calculations will be required as part of the Transport Assessment to be submitted by the developer as part of any planning application. For calculating the impact of demand management measures in this TA, an indicative 30-minute frequency bus service has been assumed. If the capacity of a bus is assumed to be 80 passengers (the capacity of the vehicles used will depend on the operator), a 30-minute frequency service would have capacity to carry 160 passengers per hour in each direction. A well-used bus service could therefore provide nil-detriment at the three junctions in **Table 29** if passengers that would otherwise drive through the junctions in question choose to travel by bus instead. These passenger trips could be generated by Ordsall South, other Local Plan allocation sites and / or the existing population. The impact of bus services to provide demand management mitigation measures should be explored further as part of a TA to be submitted with a planning application.

11.18 MITIGATION SUMMARY

11.18.1 A summary of the possible walking/cycling and public transport mitigation discussed in this chapter is presented in **Table 30** below. All costs are very preliminary 'ball park' estimates intended to provide an approximate indication of the likely scale of costs involved.

Table 30 – Summary of Sustainable Modes Mitigation

Description	Likely Improvement	Indicative Costs
Public Transport Improvements	New bus service funded for 5 years	£1.4m
Walking & Cycling	New and improved walking and cycling connections to the site	£0.75m

11.18.2 A summary of off-site highway infrastructure improvements to mitigate residual traffic impacts is presented in **Appendix L** and summarised in **Table 31**.

Table 31 – Summary of Off-Site Highway Infrastructure Costs

Junction	Likely Improvement	Indicative Costs
Junction 2A - Apleyhead Interchange (A57 /Blyth Road / A1)	Re-allocation of lanes and minor kerb re-alignment	£540k
Junction 6 - A620 Babworth Rd/B6420 Mansfield Rd/A620 Straight Mile/Sutton Lane	Introduction of signal-control	£2.15m
Junction 7 - A620 Babworth Road/Ordsall Road	Introduction of signal-control	£1.08m
Junction 9 - A620 Amcott Way/A620 Moorgate/A638 Arlington Way	Improvements to existing signal-controlled layout	£1.08m
Junction 14 - A638 London Road/Whitehouses Road	Introduction of signal-control	£1.08m
Junction 15 - London Road / Whinney Moor Lane / Bracken Lane	Introduction of signal-control	£1.08m

11.18.3 As indicated in the table in **Appendix L**, a suggested proportional split for infrastructure costs is identified. This is based on the number of development trips from each Local Plan allocation site passing through each junction in the highway peak hours as a proportion of the total Local Plan allocation trips from all sites. All costs are very preliminary 'ball park' estimates intended to provide an approximate indication of the likely scale of costs involved.

11.18.4 The mitigation requirements for each Local Plan allocation site will need to be determined at the planning application stage through the submission of a Transport Assessment produced in accordance with the NPPF. The developer will be required to assess the transport implication of the development and the cumulative implications of any other committed land-use development

and transport schemes in the local area. Appropriate transport mitigation will need to be identified and agreed with the highway authority to address any residual traffic impacts.

12 SUMMARY

12.1 INTRODUCTION

- 12.1.1 This study assesses the impact of a potential development of 930 dwellings (1,250 as part of a sensitivity test) at the Ordsall South site on Ollerton Road, Retford. The site is allocated in the Draft Bassetlaw Local Plan under reference HS13 for approximately 890 dwellings.
- 12.1.2 The site currently comprises agricultural land and is bound to the north by residential development and Retford Golf Club, and to the east, west and south by agricultural land.
- 12.1.3 For the purposes of this study it has been assumed that the site will be accessed from two new roundabouts onto Ollerton Road with land to the east and west of Ollerton Road accessed from separate arms onto the roundabouts. Land to the west will be accessed from both roundabouts and land to the east will be accessed from one roundabout.
- 12.1.4 Existing bus services stopping close to the site are not high frequency services. Enhancements to these services, or the provision of new complimentary services should therefore be provided by the developer to ensure that residents on the completed development have sustainable travel choices available. The layout of the site should also be configured to allow bus penetration into the western parcel of land, as a minimum.
- 12.1.5 The site developer will be required to deliver new and improved walking and cycling infrastructure to connect the development to neighbouring areas and facilitate safe travel by these modes. A detailed access strategy will need to be identified at the planning application stage. Subject to NCC approval in relation to LTN 1/20, as a minimum this should include footways and marked cycle routes along Ollerton Road to connect the site to Ordsall plus the new and improved pedestrian and cycle links as detailed in Policy ST27 (for Site HS13) of the Bassetlaw Local Plan 2020-2037 Publication Version Addendum January 2022.
- 12.1.6 Ordsall residents have previously suggested that a new link road between Ollerton Road and the A638 would be beneficial and the merits of a possible link road to mitigate development traffic impacts have been examined. However, initial investigations suggest that providing a new link road is likely to prove technically very challenging and prohibitively expensive. It would also provide no relief for development trips passing through or around Retford town centre. As a result it is unlikely that a new link road could be justified as the costs would far outweigh the benefits.
- 12.1.7 At some town centre locations within Retford it will be very difficult to deliver any meaningful mitigation in the form of increased junction capacity due to the physical space constraints that exist within the urban environment and because at many locations opportunities to achieve additional traffic capacity appear to have already been taken.

- 12.1.8 The site developer will therefore need to focus on minimising travel demand (e.g. by facilitating home working through the provision of high speed broadband etc) and seeking to ensure that as many new trips are made by sustainable travel modes as possible.
- 12.1.9 The site developer will also be required to deliver off-site highway infrastructure improvements to mitigate residual traffic impacts. Details of which will need to be determined at the planning application stage through the submission of a Transport Assessment produced in accordance with the NPPF. The developer will be required to assess the transport implication of the site and the cumulative implications of any other committed land-use development and transport schemes in the local area. Appropriate transport mitigation will need to be identified and agreed with the highway authority to address residual traffic impacts.
- 12.1.10 This TA has identified that nine off-site junctions are likely to require physical mitigation. A preliminary approach to mitigation has been identified with walking/cycling improvements, bus service improvements and off-site junction improvements identified.
- 12.1.11 Delivery of mitigation will be secured through the planning approval process. Mitigation could take the form of a S106 contribution towards a scheme(s) or delivery of a scheme(s) in full. NCC may opt for a comprehensive scheme at a specific junction rather than several smaller piecemeal improvements at several junctions. In this scenario, a comprehensive scheme would also address existing capacity problems as well as the impact of the development.

Figures

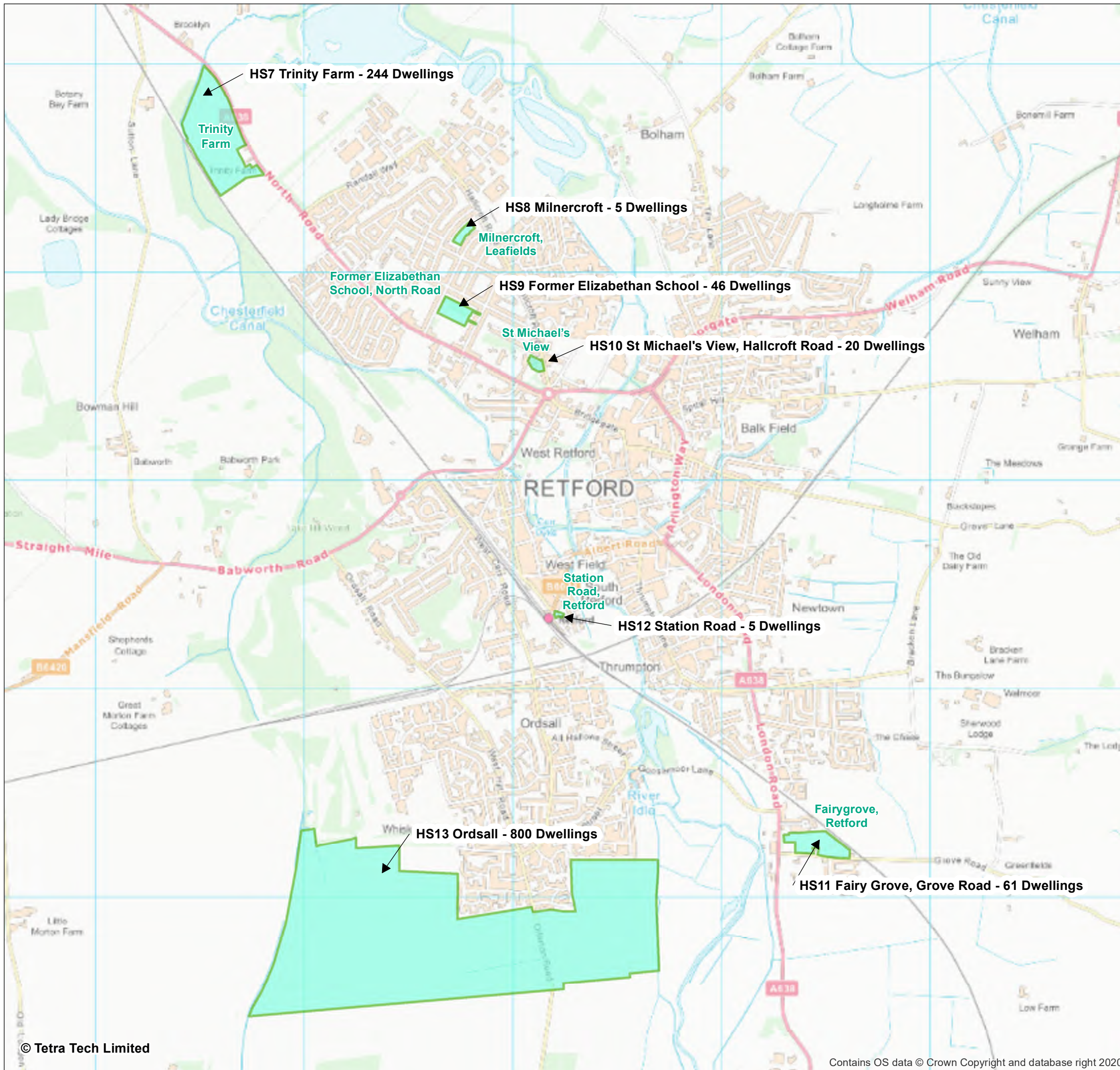

Figure 1 Retford Development Sites
 Ordsall, Retford

Bassetlaw District Council

Legend
 Allocation Sites

Notes:

Drawn by: JC
 Checked by: RJH
 Approved by: ASG

Drawing No. 006
 Revision No. -

04 June 2021
 NGR: 470,255 E / 380,729 N

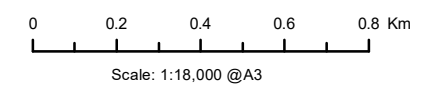

© Crown Copyright All rights reserved. Licence number:

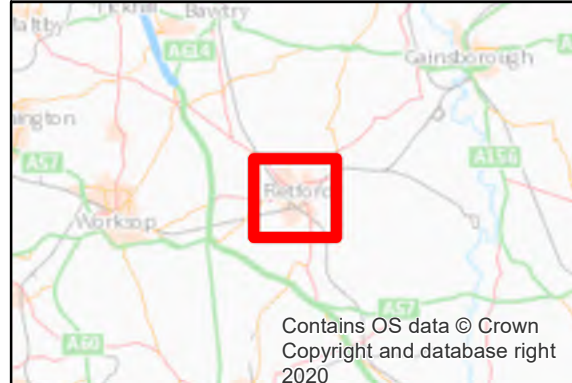

Tetra Tech

Executive Park
 Avalon Way
 Anstey
 Leicestershire
 LE7 7GR

TEL: 0116 234 8000
 Email: europe@tetratech.com

Figure 2 Ordsall South Site Location

Ordsall, Retford



Bassetlaw District Council

Legend

- Local Amenities
- 🚌 Bus Stops
- PROWs
- Site Boundary

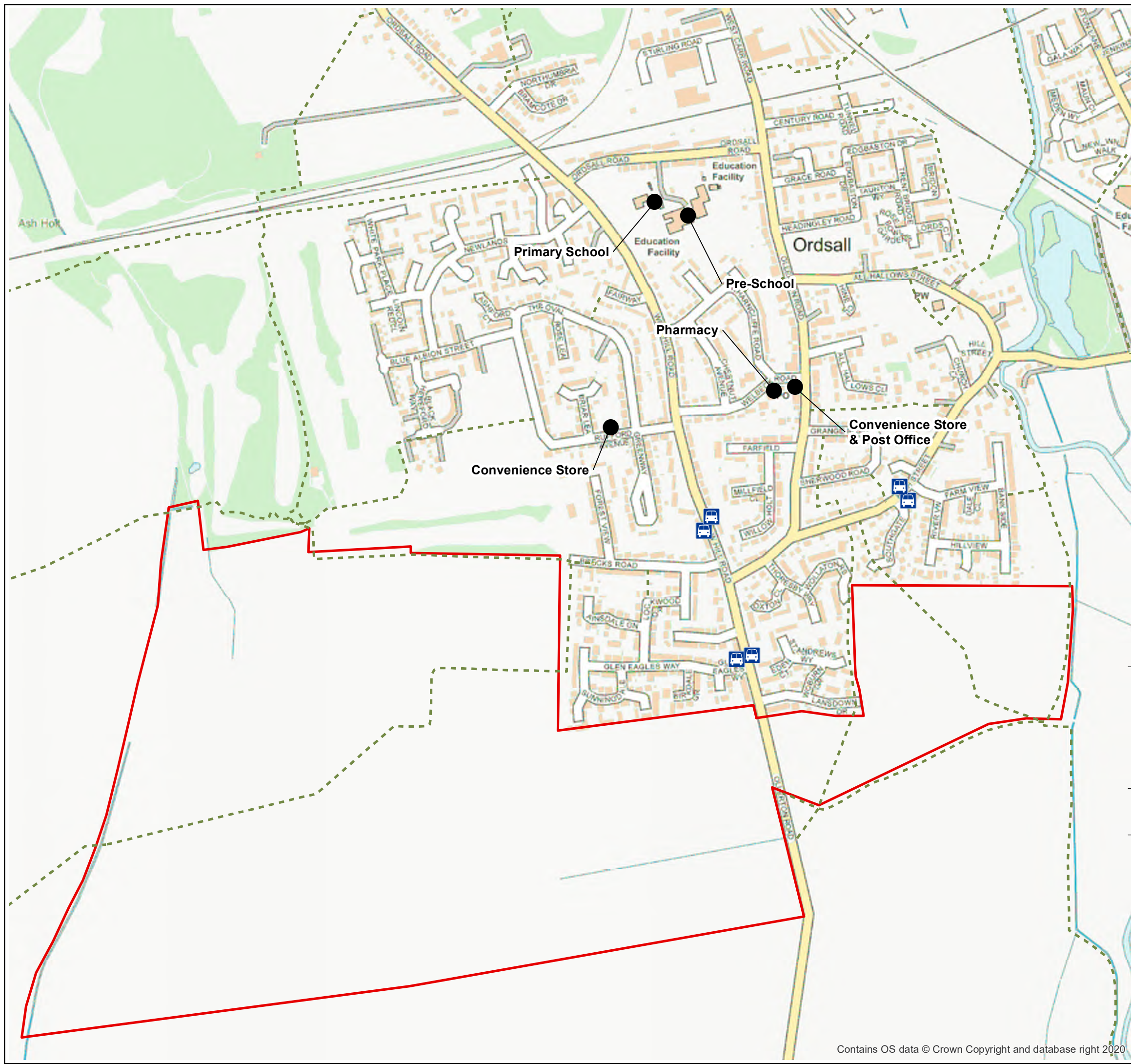

Notes:

Drawn by: LW
Checked by: RJH
Office: Nottingham

Drawing No. 001
Revision No. -

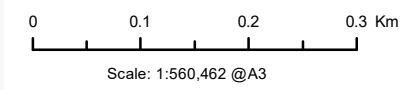

07 June 2021
NGR: 470,949 E / 379,835 N

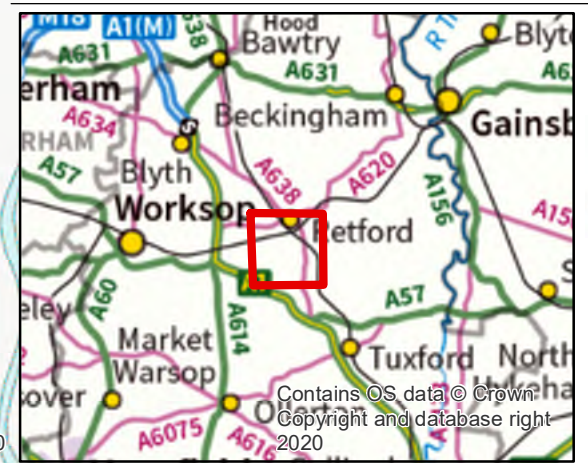

Geneva Building
Lake View Drive
Sherwood Business Park
Nottingham
NG15 0ED

TEL: +44 (0)1623 684550
Email: nottingham@tetratech.com

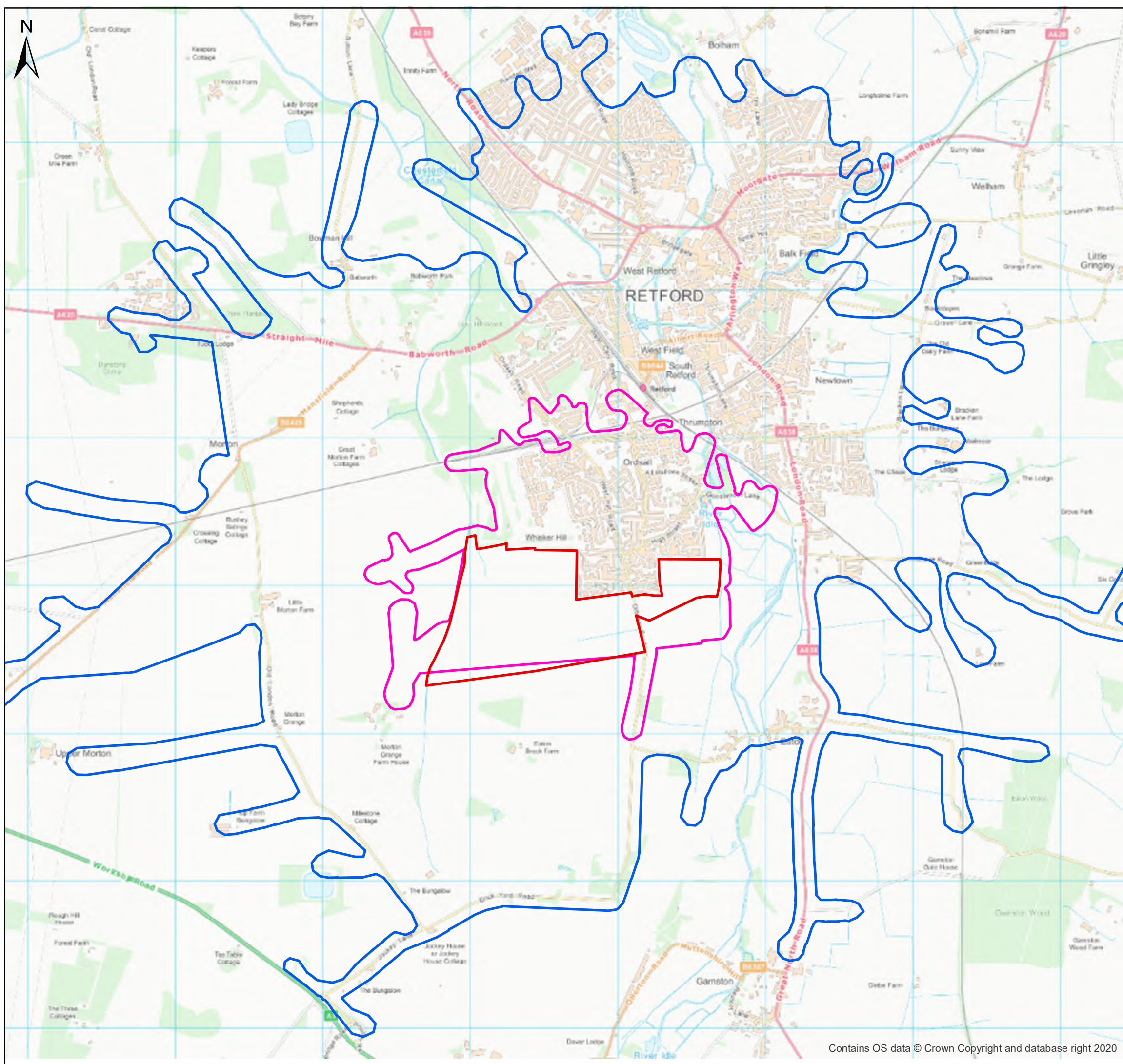

Figure 5 - 2km and 5km Catchment Plan
 Ordsall, Retford
 Bassetlaw District Council

- Legend**
- Site Boundary
 - 2km Walking Catchment
 - 5km Cycling Catchment

Notes:

Drawn by: LW
 Checked by: RJH
 Office: Nottingham

Drawing No. 002
 Revision No. -

0 0.35 0.7 1.05 Km
 Scale: 1:560,462 @A3

07 June 2021
 NGR: 470,949 E / 379,835 N



Tt
TETRA TECH

Geneva Building
 Lake View Drive
 Sherwood Business Park
 Nottingham
 NG15 0ED

Contains OS data © Crown
 Copyright and database right
 2020

TEL: +44 (0)1623 684550
 Email: nottingham@tetratech.com

Figure 6 - Personal Injury Collision Data

Ordsall, Retford

Bassetlaw District Council

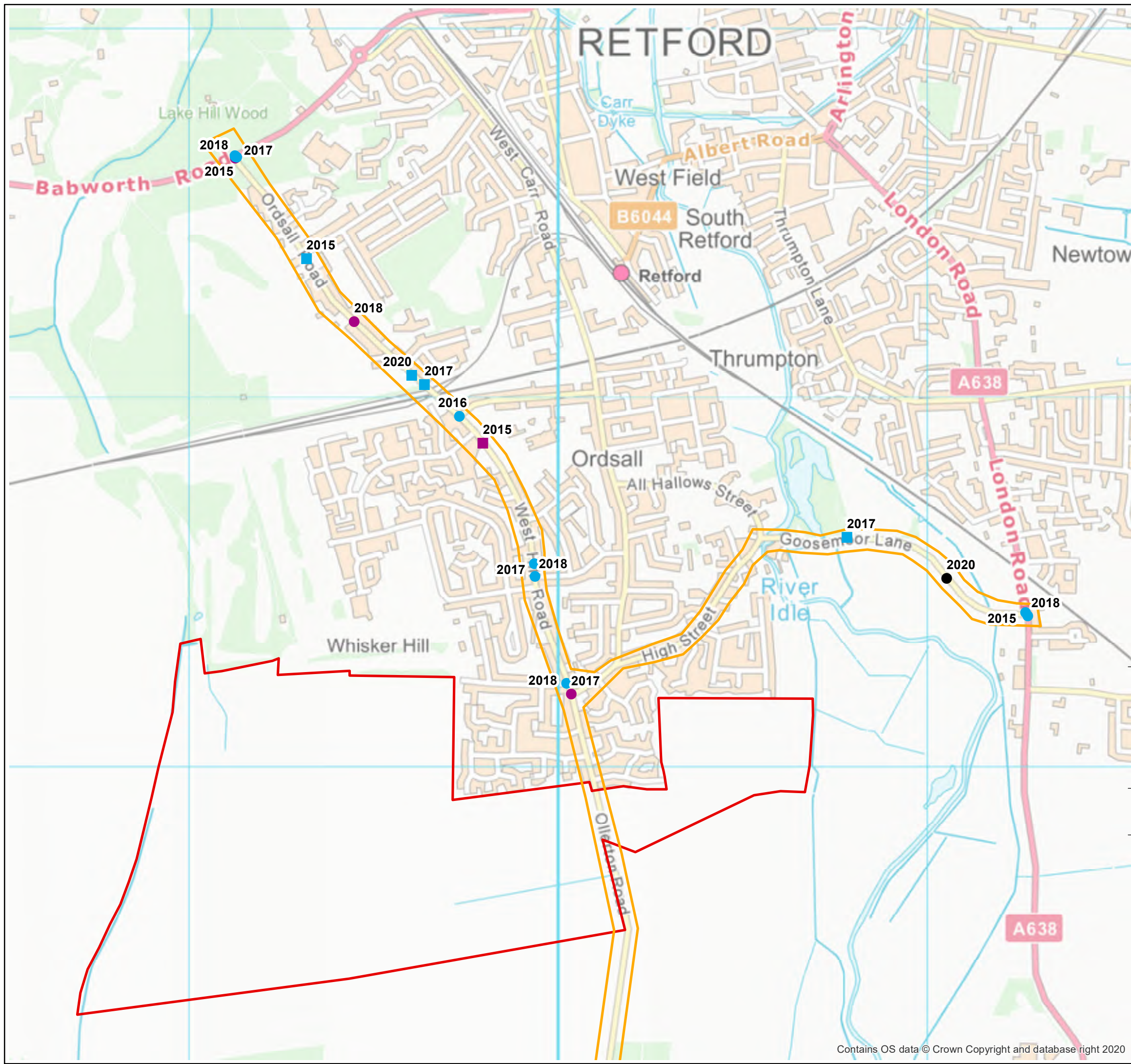

Legend

- Site Boundary
- Collision Data Study Area

Severity/Road User Involved

- Slight Collision Pedestrian Involved
- Slight Collision Vehicle Only
- Serious Collision Pedestrian Involved
- Serious Collision Vehicle Only
- Fatal Collision Vehicle Only

Notes:

Drawn by: ES
 Checked by: RJH
 Office: Nottingham

Drawing No. 003
 Revision No. -

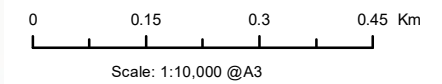

07 June 2021

NGR: 470,035 E / 379,631 N

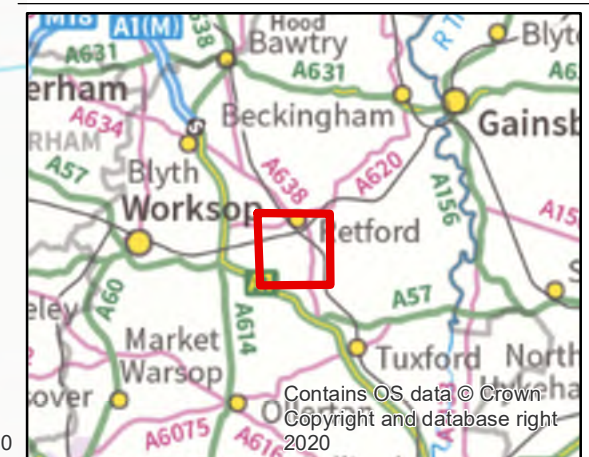

Geneva Building
 Lake View Drive
 Sherwood Business Park
 Nottingham
 NG15 0ED

TEL: +44 (0)1623 684550
 Email: nottingham@tetratech.com

Appendix A - Site Boundary

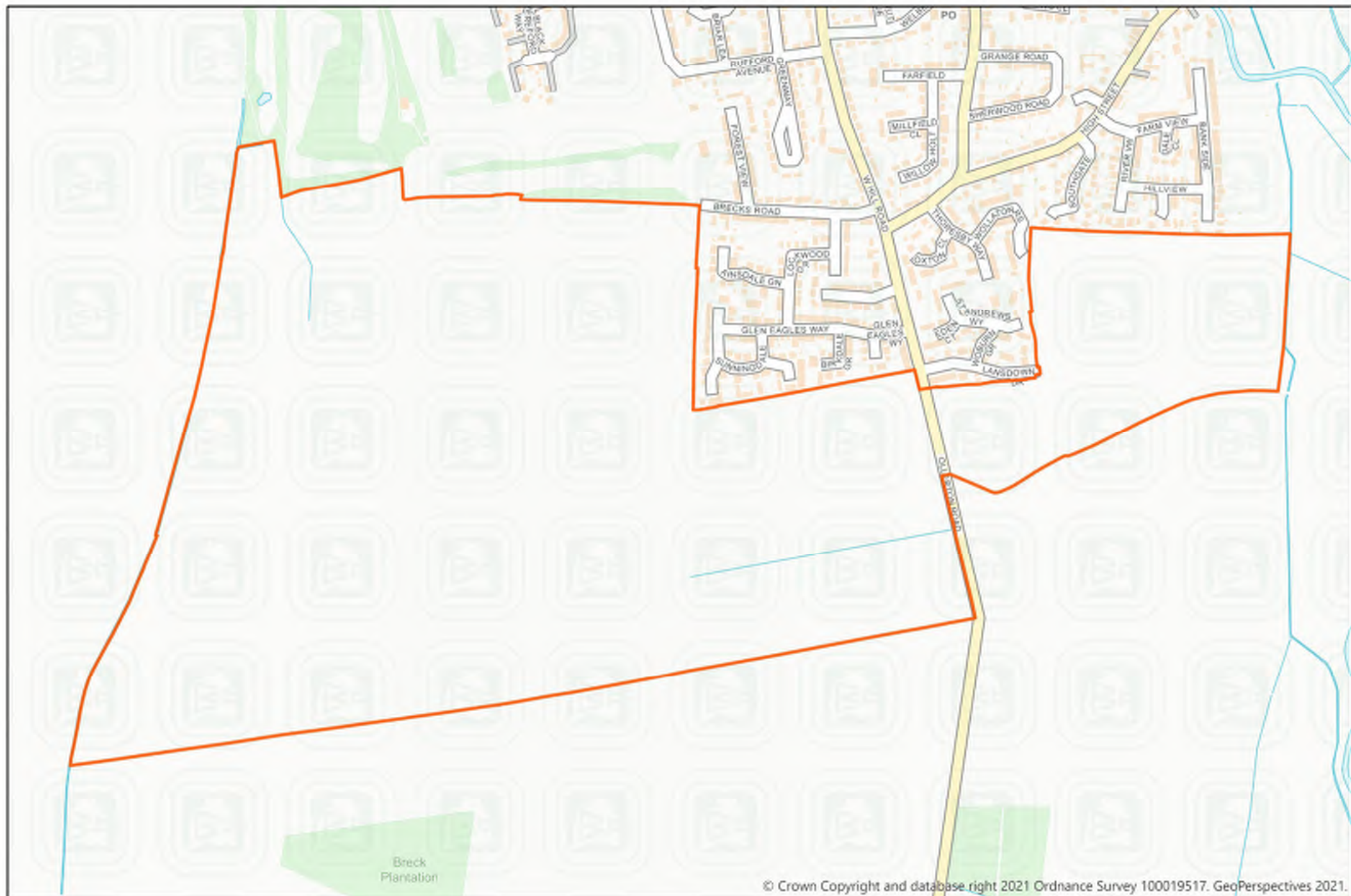

© Crown Copyright and database right 2021 Ordnance Survey 100019517. GeoPerspectives 2021.

Appendix B – TA Scoping Correspondence

Holland, Robert

From: Martin Green <martin.green@nottscc.gov.uk>
Sent: 04 December 2020 08:01
To: Holland, Robert
Subject: RE: Land at Ollerton Road, Ordsall

Hi Robert

The committed developments I mentioned earlier would be applicable here; residential development at Tiln Lane (14/00503/OUT), mixed use development at North Road, Retford (15/00493/OUT), retail park London Road/South Street including a Lidl (16/00015/FUL). I probably should have also mentioned, with respect the Garden Village; the residential development at the former Kenilworth Nurseries on London Road (16/01777/FUL & 18/00695/FUL), and the residential development at Bracken Lane, Retford (19/00765/OUT) which will also need consideration.

The scope of the assessment will need to include Main Street Eaton which links Ollerton Road to London Road. There's a narrow bridge, poor alignment, accesses with limited visibility splays, no footways etc. This could be a show stopper if it would be likely to experience a material increase in traffic. Unfortunately it's a more convenient route to the south than Goosemoor Lane. I'd also be grateful if you could include the Goosemoor Lane/High Street and Whinney Moor Lane/London Road junctions. More generally I will be seeking all main junctions that will experience greater the 30 two-way peak hour movements to be included within the scope of the assessment. The A638/B6387 is a popular route towards Ollerton, but I'm not sure whether it would exceed the threshold.

I do not have a copy of the completed S106 but I believe application reference 18/00695/FUL mentioned above includes a financial contribution of £250,000 towards either a scheme to provide improvements to mitigate the impact of the scheme on the London Road/Whinney Moor Lane junction, or to provide measures to reduce traffic and congestion on the London Road transport corridor.

Kind regards

Martin Green
Principal Officer
Nottinghamshire County Council
Telephone 0115 9773963
www.nottinghamshire.gov.uk

From: Holland, Robert <Robert.Holland@tetrattech.com>
Sent: 03 December 2020 18:02
To: Martin Green <martin.green@nottscc.gov.uk>
Subject: Land at Ollerton Road, Ordsall

Hi Martin

We've been appointed by Bassetlaw District Council (BDC) to undertake a transport study of a potential residential development to the south of Ordsall to help inform Local Plan work. It will essentially be a Transport Assessment but the document won't form part of a planning application, not for now anyway. I've attached a plan showing the site boundary. We've been asked to consider 800 dwellings at the site with vehicular access from Ollerton Road.

We'd be grateful for your thoughts on the site in general and the approach we're taking as we're keen to ensure anything we do now isn't abortive if a planning application is prepared further down the line. We will be taking the following general approach:

- A description of proposed uses for the site.
- Summary of relevant planning policy documents.

- Analysis of existing conditions.
- Review of local sustainable transport facilities (walking, cycling, bus and rail), including walking and cycling catchments (2.0km for walking and 5.0km for cycling). Explore the opportunities and constraints. Identify improvements where necessary.
- Analysis of the most recently available 5 year period of collision data for the area shown on the attached plan.
- Study area for trip distribution to consist of the site access(es) on Ollerton Road and off-site junctions as advised by NCC. As a starting point, we propose the following as shown on the attached plan:
 1. A1/A620 Retford Road/B6079 Retford Road
 2. A1/B6420 Mansfield Road/A614 Blyth Road/A57
 3. A1/Elkesley Bridge Road/Jockey Lane/Eskil Way
 4. A1/B6387 Dover Bottom
 5. A1 Markham Moor Junction
 6. A620 Babworth Road/B6420 Mansfield Road/A620 Straight Mile/Sutton Lane
 7. A620 Babworth Road/Ordsall Road
 8. A620 Amcott Way/Bridlegate/A620 Hospital Road/A638 North Road/Hallcroft Road
 9. A620 Amcott Way/A620 Moorgate/A638 Arlington Way
 10. A638 Arlington Way/Spital Hill/Chapelgate
 11. A638 Arlington Way/Grove Street
 12. A638 Arlington Way/A638 London Road/Carolgate
 13. Ollerton Road/West Hill Road
 14. A638 London Road/Whitehouses Road
- Trip generation calculated using trip rates from the TRICS database.
- Trip distribution using Travel to Work data from the 2011 Census with route choices obtained from the VISSIM model that we've used to distribute trips when looking at the Cottam Power Station and Morton Garden Village sites for BDC. We will use the 'Bassetlaw 010' Middle Super Output Area.
- TA assessment year of 2031 i.e. 10 years from 2021. Assessments to consider the weekday AM and PM peak hours.
- Traffic growth using TEMPRO adjusted NTM growth factors for the local area.
- Capacity assessments at the site access junction(s) and off-site junctions where we have a severe impact. At this stage we will include any junction with a peak hour impact greater than 30 vehicles.

Please could you advise of any committed developments/schemes we should take into account. BDC has indicated that NCC may have an improvement scheme in the pipeline for a nearby junction – London Road/Whitehouses Road? Please advise of any implications for our site.

Any further comments you can add at this stage would be appreciated e.g. anything on likely S106 contributions.

Please let me know if you have any queries.

Many thanks

Rob Holland
Associate Director

WYG will be rebranding to Tetra Tech at the start of 2021

WYG

Geneva Building, Lake View Drive, Sherwood Business Park, Annesley, Nottingham, NG15 0ED

Tel: +44 116 234 8176

Mob: +44 7824 431 929

www.wyg.com

WYG Environment Planning Transport Limited. Registered in England number: 03050297.
Registered Office: 3 Sovereign Square, Sovereign Street, Leeds LS1 4ER. VAT No: 431-0326-08.



The following message has been applied automatically, to promote news and information from Nottinghamshire County Council about events and services:



Nottinghamshire County Council is committed to protecting your privacy and ensuring all personal information is kept confidential and safe – for more details see <https://www.nottinghamshire.gov.uk/global-content/privacy>

Emails and any attachments from Nottinghamshire County Council are confidential. If you are not the intended recipient, please notify the sender immediately by replying to the email, and then delete it without making copies or using it in any other way. Senders and recipients of email should be aware that, under the Data Protection Act 2018 and the Freedom of Information Act 2000, the contents may have to be disclosed in response to a request.

Although any attachments to the message will have been checked for viruses before transmission, you are urged to carry out your own virus check before opening attachments, since the County Council accepts no responsibility for loss or damage caused by software viruses.

You can view our privacy notice at: <https://www.nottinghamshire.gov.uk/global-content/privacy>

Nottinghamshire County Council Legal Disclaimer.

Appendix C – Traffic Data

BASE COUNTS

AM Peak Hour
PM Peak Hour

Segment	AM Peak Hour	PM Peak Hour
1	100	100
2	100	100
3	100	100
4	100	100
5	100	100
6	100	100
7	100	100
8	100	100
9	100	100
10	100	100
11	100	100
12	100	100
13	100	100
14	100	100
15	100	100
16	100	100
17	100	100
18	100	100
19	100	100
20	100	100
21	100	100
22	100	100
23	100	100
24	100	100
25	100	100
26	100	100
27	100	100
28	100	100
29	100	100
30	100	100
31	100	100
32	100	100
33	100	100
34	100	100
35	100	100
36	100	100
37	100	100
38	100	100
39	100	100
40	100	100
41	100	100
42	100	100
43	100	100
44	100	100
45	100	100
46	100	100
47	100	100
48	100	100
49	100	100
50	100	100
51	100	100
52	100	100
53	100	100
54	100	100
55	100	100
56	100	100
57	100	100
58	100	100
59	100	100
60	100	100
61	100	100
62	100	100
63	100	100
64	100	100
65	100	100
66	100	100
67	100	100
68	100	100
69	100	100
70	100	100
71	100	100
72	100	100
73	100	100
74	100	100
75	100	100
76	100	100
77	100	100
78	100	100
79	100	100
80	100	100
81	100	100
82	100	100
83	100	100
84	100	100
85	100	100
86	100	100
87	100	100
88	100	100
89	100	100
90	100	100
91	100	100
92	100	100
93	100	100
94	100	100
95	100	100
96	100	100
97	100	100
98	100	100
99	100	100
100	100	100

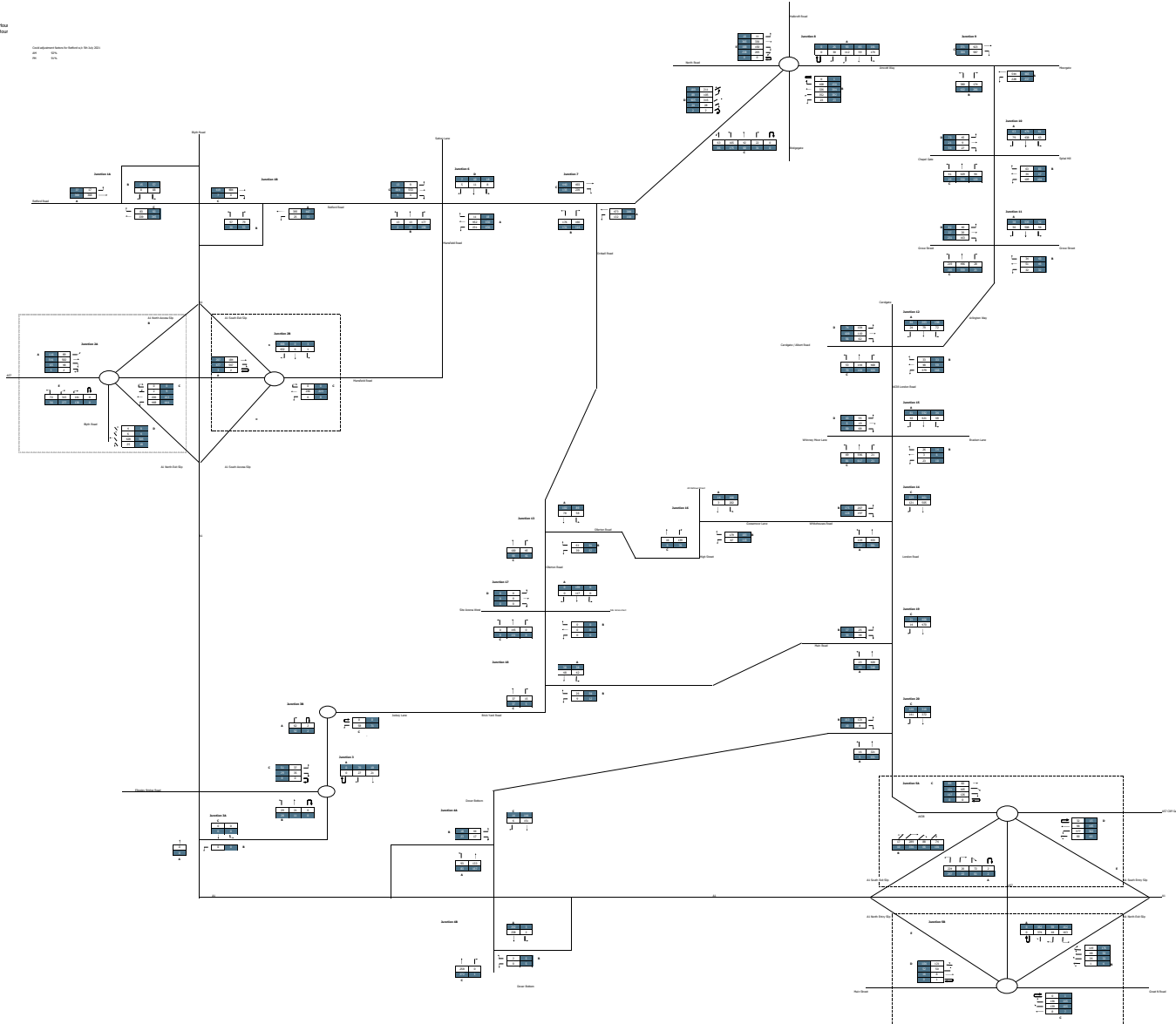

Appendix D – Collision Data



Accident Details Report

Ordsall Rd - Ollerton Rd - Goosemoor Rd - Ordsall Period 1-1-15 to 30-9-20 by nthing DR4644

Total number of reports = **19**

Total number of pages (including this page) = **20**

ROAD TRAFFIC INJURY ACCIDENT RECORDS - DISCLAIMER

These details are a record of the personal injury accidents reported to the Police. Every endeavour is made to ensure the accuracy and completeness of these records, which have been transcribed from the original Police Reports. The data is then entered and held on computer.

Occasions may arise when information from the Police, relevant to a particular accident, may not be available for several months and will therefore not be included.

No. 1	District Bassetlaw	<h1>Accident Details</h1>	VRUs	Grid Reference 470093 / 377887
SEVERITY SLIGHT	Ref.No 2B167619		Police Officer Attend: Yes	
Date 21/09/2019 Day Saturday	ROAD U	LOCATION OLLERTON ROAD, at its Junction with U/C UNAMED ROAD,1060M SW LANSDOWN DRIVE RETFORD		
Time 10:11				
Weather Fine				
Road Surface Dry				
Street Lighting Daylight				
Speed Limit 60 MPH	SITE DETAILS	SPECIAL SITE CONDITIONS		
Carriageway Single c'way		None		
Lane markings Centre/hazard line				
Junction Detail Crossroads				
Junction Control Give way sign or uncontrolled		CARRIAGEWAY HAZARDS		
2nd Road Number U		None		
Pedestrian Facilities No Human control within 50m and No crossing facility within 50m				
VEHICLES INVOLVED 2		CASUALTIES INVOLVED 2		
Veh.No. 1 Vehicle type Van/Goods < 3.5t	Manoeuvre Going ahead other	Cas No 1 Cas Class Driver or Rider Veh ref No 2	Severity SLIGHT Age 52 yrs Sex Male	
Direction from South west to North east Towing? No	Skidded Yes	Car Passenger? No PSV Passenger? No	Ped Movement Not a pedestrian	
Veh location at impact (restricted lane) On main carriageway	Junct. location of veh. at 1st impact Approaching or parked on approach to junction	Ped location Not a pedestrian	Ped Direction to Not a pedestrian	
Veh left carriageway? Did not leave c'way	Hit object in c'way? None	School Pupil Other	Roadworker injured No	
Hit object off c'way? None	First point of impact Front	Cas No 2 Cas Class Passenger Veh ref No 2	Severity SLIGHT Age 56 yrs Sex Female	
Drivers age 39 yrs Sex Male Other veh.hit (ref.) 2 Hit and run No	Foreign vehicle Not foreign Breath test Negative	Car Passenger? Front PSV Passenger? No	Ped Movement Not a pedestrian	
Journey purpose		Ped location Not a pedestrian	Ped Direction to Not a pedestrian	
Veh.No. 2 Vehicle type Car	Manoeuvre Turning right	School Pupil Other	Roadworker injured No	
Direction from South west to South east Towing? No	Skidded No			
Veh location at impact (restricted lane) On main carriageway	Junct. location of veh. at 1st impact Leaving main road			
Veh left carriageway? Did not leave c'way	Hit object in c'way? None			
Hit object off c'way? None	First point of impact Back			
Drivers age 52 yrs Sex Male Other veh.hit (ref.) 1 Hit and run No	Foreign vehicle Not foreign Breath test Negative			
Journey purpose				

No. 2	District Bassetlaw	<h1>Accident Details</h1>	VRUs	Grid Reference 470036 / 379196
SEVERITY SERIOUS	Ref.No 2B163717		Police Officer Attend: Yes	
Date 26/07/2017 Day Wednesday	ROAD U	LOCATION U/C WEST HILL ROAD, at its Junction with U/C OLLERTON ROAD, RETFORD		
Time 18:47				
Weather Fine				
Road Surface Dry				
Street Lighting Daylight				
Speed Limit 30 MPH	SITE DETAILS	SPECIAL SITE CONDITIONS		
Carriageway Single c'way	None			
Lane markings Centre/hazard line				
Junction Detail T or Staggered junction				
Junction Control Give way sign or uncontrolled	CARRIAGEWAY HAZARDS			
2nd Road Number U	None			
Pedestrian Facilities No Human control within 50m and No crossing facility within 50m				
VEHICLES INVOLVED 2		CASUALTIES INVOLVED 1		
Veh.No. 1 Vehicle type Car	Cas No 1 Cas Class Driver or Rider Veh ref No 2		Severity SERIOUS Age 75 yrs Sex Female	
Manoeuvre Turning left	Car Passenger? No PSV Passenger? No		Ped Movement Not a pedestrian	
Direction from North east to South Towing? No	Ped location Not a pedestrian		Ped Direction to Not a pedestrian	
Skidded Yes	School Pupil Other		Roadworker injured No	
Veh location at impact (restricted lane) On main carriageway				
Junct. location of veh. at 1st impact Entering main road				
Veh left carriageway? Did not leave c'way				
Hit object in c'way? None				
Hit object off c'way? None				
First point of impact Front				
Drivers age U/K yrs Sex Male Other veh.hit (ref.) 2 Hit and run No				
Foreign vehicle Not foreign Breath test Not contacted				
Journey purpose Other/Not known				
Veh.No. 2 Vehicle type Car				
Manoeuvre Going ahead other				
Direction from South to North Towing? No				
Skidded No				
Veh location at impact (restricted lane) On main carriageway				
Junct. location of veh. at 1st impact Mid junction				
Veh left carriageway? Did not leave c'way				
Hit object in c'way? None				
Hit object off c'way? None				
First point of impact Front				
Drivers age 75 yrs Sex Female Other veh.hit (ref.) 1 Hit and run No				
Foreign vehicle Not foreign Breath test Negative				
Journey purpose Other/Not known				

No. 3	District Bassetlaw	<h1>Accident Details</h1>	VRUs Motorcycle	Grid Reference 470023 / 379226
SEVERITY SLIGHT	Ref.No 2B260318		Police Officer Attend: Yes	
Date 12/12/2018 Day Wednesday	ROAD U	LOCATION U/C WEST HILL ROAD, at its Junction with U/C BRECKS ROAD, RETFORD		
Time 22:16				
Weather Fine				
Road Surface Wet				
Street Lighting Dark/lights lit				
Speed Limit 30 MPH	SITE DETAILS	SPECIAL SITE CONDITIONS		
Carriageway Single c'way	None			
Lane markings Centre/hazard line				
Junction Detail T or Staggered junction				
Junction Control Give way sign or uncontrolled	CARRIAGEWAY HAZARDS			
2nd Road Number U	None			
Pedestrian Facilities No Human control within 50m and No crossing facility within 50m				
VEHICLES INVOLVED 2		CASUALTIES INVOLVED 1		
Veh.No. 1	Vehicle type M/cycle 50 - 125cc	Cas No 1	Cas Class	Driver or Rider Veh ref No 1
Manoeuvre Going ahead other		Severity SLIGHT	Age 18 yrs	Sex Male
Direction from North west to South east	Towing? No	Car Passenger? No	PSV Passenger? No	
Skidded Yes		Ped Movement Not a pedestrian		
Veh location at impact (restricted lane) On main carriageway		Ped location Not a pedestrian		
Junct. location of veh. at 1st impact Mid junction		Ped Direction to Not a pedestrian		
Veh left carriageway? Did not leave c'way		School Pupil Other		
Hit object in c'way? None		Roadworker injured No		
Hit object off c'way? None				
First point of impact Front				
Drivers age 18 yrs Sex Male	Other veh.hit (ref.) 2	Hit and run No		
Foreign vehicle Not foreign		Breath test Negative		
Journey purpose Other/Not known				
Veh.No. 2	Vehicle type Car			
Manoeuvre Turning right				
Direction from South west to South east	Towing? No			
Skidded No				
Veh location at impact (restricted lane) On main carriageway				
Junct. location of veh. at 1st impact Entering main road				
Veh left carriageway? Did not leave c'way				
Hit object in c'way? None				
Hit object off c'way? None				
First point of impact Nearside				
Drivers age 28 yrs Sex Male	Other veh.hit (ref.) 1	Hit and run No		
Foreign vehicle Not foreign		Breath test Negative		
Journey purpose				

No. 4	District Bassetlaw	<h1>Accident Details</h1>	VRUs	Grid Reference 471274 / 379409
SEVERITY SLIGHT	Ref.No 2B161418		Police Officer Attend: Yes	

Date 23/08/2018 Day Thursday	ROAD A638
Time 13:17	LOCATION A638 LONDON ROAD M-RBT, at its Junction with U/C WHITEHOUSES ROAD, RETFORD
Weather Fine	
Road Surface Dry	
Street Lighting Daylight	

Speed Limit 40 MPH	SITE DETAILS	SPECIAL SITE CONDITIONS
Carriageway Roundabout		None
Lane markings Centre/hazard line		
Junction Detail Mini Roundabout		
Junction Control Give way sign or uncontrolled		CARRIAGEWAY HAZARDS
2nd Road Number U		None
Pedestrian Facilities No Human control within 50m and Central Refuge only		

VEHICLES INVOLVED 2	CASUALTIES INVOLVED 1
---------------------	-----------------------

Veh.No. 1 Vehicle type Car Manoeuvre Going ahead other Direction from South to North Towing? No Skidded No Veh location at impact (restricted lane) On main carriageway Junct. location of veh. at 1st impact Entering roundabout Veh left carriageway? Did not leave c'way Hit object in c'way? None Hit object off c'way? None First point of impact Offside Drivers age 70 yrs Sex Female Other veh.hit (ref.) 2 Hit and run No Foreign vehicle Not foreign Breath test Negative Journey purpose Other/Not known	Cas No 1 Cas Class Driver or Rider Veh ref No 1 Severity SLIGHT Age 70 yrs Sex Female Car Passenger? No PSV Passenger? No Ped Movement Not a pedestrian Ped location Not a pedestrian Ped Direction to Not a pedestrian School Pupil Other Roadworker injured No
---	--

Veh.No. 2 Vehicle type Car Manoeuvre Turning right Direction from North to West Towing? No Skidded No Veh location at impact (restricted lane) On main carriageway Junct. location of veh. at 1st impact Mid junction Veh left carriageway? Did not leave c'way Hit object in c'way? None Hit object off c'way? None First point of impact Front Drivers age 21 yrs Sex Female Other veh.hit (ref.) 1 Hit and run No Foreign vehicle Not foreign Breath test Negative Journey purpose Other/Not known

No. 5	District Bassetlaw	<h1>Accident Details</h1>	VRUs	Grid Reference 471268 / 379417
SEVERITY SLIGHT	Ref.No 2B136515		Police Officer Attend: No - reported over the counter	
Date 13/07/2015 Day Monday	ROAD A638	LOCATION A638 LONDON ROAD, at its M-RBT Junction with Unclassified Road WHITEHOUSE ROAD (AKA GOOSEMOOR LN), EAST RETFORD		
Time 11:30				
Weather Fine				
Road Surface Dry				
Street Lighting Daylight				
Speed Limit 40 MPH	SITE DETAILS	SPECIAL SITE CONDITIONS		
Carriageway Roundabout		None		
Lane markings Centre/hazard line				
Junction Detail Mini Roundabout				
Junction Control Give way sign or uncontrolled		CARRIAGEWAY HAZARDS		
2nd Road Number U		None		
Pedestrian Facilities No Human control within 50m and No crossing facility within 50m				
VEHICLES INVOLVED 2		CASUALTIES INVOLVED 1		
Veh.No. 1 Vehicle type Car	Manoeuvre Turning right	Towing? No	Cas No 1 Cas Class Driver or Rider Veh ref No 1	Severity SLIGHT Age 18 yrs Sex Female
Direction from West to South	Skidded No	Veh location at impact (restricted lane) On main carriageway	Car Passenger? No	PSV Passenger? No
Junct. location of veh. at 1st impact	On main carriageway	Entering roundabout	Ped Movement Not a pedestrian	
Veh left carriageway? Did not leave c'way	Hit object in c'way? None	Hit object off c'way? None	Ped location Not a pedestrian	
First point of impact Offside	Drivers age 18 yrs Sex Female	Other veh.hit (ref.) 2	Ped Direction to Not a pedestrian	
Foreign vehicle Not foreign	Journey purpose Other/Not known	Hit and run No	School Pupil Other	
		Breath test Not requested	Roadworker injured No	
Veh.No. 2 Vehicle type Car	Manoeuvre Going ahead other	Towing? No		
Direction from South to North	Skidded No	Veh location at impact (restricted lane) On main carriageway		
Junct. location of veh. at 1st impact	On main carriageway	Mid junction		
Veh left carriageway? Did not leave c'way	Hit object in c'way? None	Hit object off c'way? None		
First point of impact Front	Drivers age 34 yrs Sex Male	Other veh.hit (ref.) 1		
Foreign vehicle Not foreign	Journey purpose	Hit and run No		
		Breath test Not requested		

No. 6	District Bassetlaw	<h1>Accident Details</h1>	VRUs Motorcycle	Grid Reference 471054 / 379510
SEVERITY FATAL	Ref.No 4B078220		Police Officer Attend: Yes	
Date 19/07/2020 Day Sunday	ROAD U	LOCATION U/C GOOSEMOOR LAN/WHITEHOUSES ROAD, at its Junction with U/C PTE ENT/EXT TO GOOSEMOOR PRODUCE FARM SHOP, RETFORD		
Time 13:29				
Weather Fine				
Road Surface Dry				
Street Lighting Daylight				
Speed Limit 40 MPH	SITE DETAILS	SPECIAL SITE CONDITIONS		
Carriageway Single c'way		None		
Lane markings Centre/hazard line				
Junction Detail Using private drive or entrance		CARRIAGEWAY HAZARDS		
Junction Control Give way sign or uncontrolled		None		
2nd Road Number U				
Pedestrian Facilities No Human control within 50m and No crossing facility within 50m				
VEHICLES INVOLVED 2		CASUALTIES INVOLVED 1		
Veh.No. 1	Vehicle type M/cycle > 500cc	Cas No 1	Cas Class	Driver or Rider Veh ref No 1
Manoeuvre Going ahead other		Severity FATAL	Age 26 yrs	Sex Male
Direction from South east to North west	Towing? No	Car Passenger? No	PSV Passenger? No	
Skidded No		Ped Movement Not a pedestrian		
Veh location at impact (restricted lane) On main carriageway		Ped location Not a pedestrian		
Junct. location of veh. at 1st impact Mid junction		Ped Direction to Not a pedestrian		
Veh left carriageway? Did not leave c'way		School Pupil Other		
Hit object in c'way? None		Roadworker injured No		
Hit object off c'way? None				
First point of impact Front				
Drivers age 26 yrs Sex Male	Other veh.hit (ref.) 2	Hit and run No		
Foreign vehicle Not foreign		Breath test Not provided		
Journey purpose				
Veh.No. 2	Vehicle type Car			
Manoeuvre Turning right				
Direction from North west to West	Towing? No			
Skidded No				
Veh location at impact (restricted lane) On main carriageway				
Junct. location of veh. at 1st impact Leaving main road				
Veh left carriageway? Did not leave c'way				
Hit object in c'way? None				
Hit object off c'way? None				
First point of impact Nearside				
Drivers age 53 yrs Sex Female	Other veh.hit (ref.) 1	Hit and run No		
Foreign vehicle Not foreign		Breath test Negative		
Journey purpose Other/Not known				

No. 7	District Bassetlaw	<h1>Accident Details</h1>	VRUs	Grid Reference 469938 / 379515
SEVERITY SLIGHT	Ref.No 2B057318		Police Officer Attend: Yes	
Date 26/03/2018 Day Monday	ROAD U	LOCATION U/C WEST HILL ROAD, at its Junction with U/C WELBECK ROAD, RETFORD		
Time 13:04				
Weather Fine				
Road Surface Dry				
Street Lighting Daylight				
Speed Limit 30 MPH	SITE DETAILS	SPECIAL SITE CONDITIONS		
Carriageway Single c'way		None		
Lane markings Centre/hazard line				
Junction Detail T or Staggered junction				
Junction Control Give way sign or uncontrolled		CARRIAGEWAY HAZARDS		
2nd Road Number U		None		
Pedestrian Facilities No Human control within 50m and No crossing facility within 50m				
VEHICLES INVOLVED 2		CASUALTIES INVOLVED 2		
Veh.No. 1 Vehicle type Car	Manoeuvre Turning right	Cas No 1 Cas Class Driver or Rider Veh ref No 1		
Direction from South to East	Towing? No	Severity SLIGHT Age 19 yrs Sex Male		
Skidded No		Car Passenger? No PSV Passenger? No		
Veh location at impact (restricted lane) On main carriageway		Ped Movement Not a pedestrian		
Junct. location of veh. at 1st impact Leaving main road		Ped location Not a pedestrian		
Veh left carriageway? Did not leave c'way		Ped Direction to Not a pedestrian		
Hit object in c'way? None		School Pupil Other		
Hit object off c'way? None		Roadworker injured No		
First point of impact Front		Cas No 2 Cas Class Driver or Rider Veh ref No 2		
Drivers age 19 yrs Sex Male Other veh.hit (ref.) 2 Hit and run No		Severity SLIGHT Age 28 yrs Sex Male		
Foreign vehicle Not foreign Breath test Not requested		Car Passenger? No PSV Passenger? No		
Journey purpose Other/Not known		Ped Movement Not a pedestrian		
Veh.No. 2 Vehicle type Car	Manoeuvre Going ahead other	Ped location Not a pedestrian		
Direction from North to South	Towing? No	Ped Direction to Not a pedestrian		
Skidded No		School Pupil Other		
Veh location at impact (restricted lane) On main carriageway		Roadworker injured No		
Junct. location of veh. at 1st impact Mid junction				
Veh left carriageway? Did not leave c'way				
Hit object in c'way? None				
Hit object off c'way? None				
First point of impact Front				
Drivers age 28 yrs Sex Male Other veh.hit (ref.) 1 Hit and run No				
Foreign vehicle Not foreign Breath test Not requested				
Journey purpose Commuting to/from work				

No. 8	District Bassetlaw	<h1>Accident Details</h1>	VRUs	Grid Reference 469936 / 379549
SEVERITY SLIGHT	Ref.No 2B139817		Police Officer Attend: No - reported over the counter	
Date 08/08/2017 Day Tuesday	ROAD U	LOCATION U/C WEST HILL ROAD (BUS STOP), (APPROX) 24 metres north of WELBECK ROAD, RETFORD		
Time 12:31				
Weather Rain				
Road Surface Wet				
Street Lighting Daylight				
Speed Limit 30 MPH	SITE DETAILS	SPECIAL SITE CONDITIONS		
Carriageway Single c'way		None		
Lane markings Centre/hazard line				
Junction Detail Not at or within 20m of junction		CARRIAGEWAY HAZARDS		
Junction Control		None		
2nd Road Number				
Pedestrian Facilities No Human control within 50m and No crossing facility within 50m				
VEHICLES INVOLVED 1		CASUALTIES INVOLVED 1		
Veh.No. 1	Vehicle type Bus or Coach	Cas No 1	Cas Class Passenger	Veh ref No 1
Manoeuvre Stopping		Severity SLIGHT	Age U/K yrs	Sex Female
Direction from South to North	Towing? No	Car Passenger? No	PSV Passenger? Standing	
Skidded No		Ped Movement Not a pedestrian		
Veh location at impact (restricted lane) On main carriageway		Ped location Not a pedestrian		
Junct. location of veh. at 1st impact Not at junction		Ped Direction to Not a pedestrian		
Veh left carriageway? Did not leave c'way		School Pupil Other		
Hit object in c'way? None		Roadworker injured No		
Hit object off c'way? None				
First point of impact Did not impact				
Drivers age U/K yrs Sex Male	Other veh.hit (ref.) 0	Hit and run No		
Foreign vehicle Not foreign		Breath test Not contacted		
Journey purpose Journey as part of work				

No. 9	District Bassetlaw	<h1>Accident Details</h1>	VRUs	Grid Reference 470784 / 379621
SEVERITY SLIGHT	Ref.No 2B158417		Pedestrian	Police Officer Attend: Yes
Date 27/08/2017 Day Sunday	ROAD U	LOCATION U/C GOOSEMOOR LANE, RETFORD		
Time 03:00				
Weather Fine				
Road Surface Dry				
Street Lighting Dark/lights lit				
Speed Limit 40 MPH	SITE DETAILS	SPECIAL SITE CONDITIONS		
Carriageway Single c'way	None			
Lane markings Centre/hazard line				
Junction Detail Not at or within 20m of junction				
Junction Control	CARRIAGEWAY HAZARDS			
2nd Road Number	None			
Pedestrian Facilities No Human control within 50m and No crossing facility within 50m				
VEHICLES INVOLVED 1	CASUALTIES INVOLVED 1			
Veh.No. 1 Vehicle type Car	Cas No 1 Cas Class Pedestrian Veh ref No 1			
Manoeuvre Going ahead other	Severity SLIGHT Age 31 yrs Sex Male			
Direction from East to West Towing? No	Car Passenger? No PSV Passenger? No			
Skidded No	Ped Movement Crossing from drivers nearside			
Veh location at impact (restricted lane) On main carriageway	Ped location In c'way crossing elsewhere			
Junct. location of veh. at 1st impact Not at junction	Ped Direction to North			
Veh left carriageway? Did not leave c'way	School Pupil Other			
Hit object in c'way? None	Roadworker injured No			
Hit object off c'way? None				
First point of impact Front				
Drivers age U/K yrs Sex Not traced Other veh.hit (ref.) 0 Hit and run Yes				
Foreign vehicle Not foreign Breath test Not contacted				
Journey purpose				

No. 10	District Bassetlaw	<h1>Accident Details</h1>	VRUs	Grid Reference 469796 / 379877
SEVERITY SERIOUS	Ref.No 2B224615		Pedestrian	Police Officer Attend: Yes
Date 19/10/2015 Day Monday	ROAD C45	LOCATION C45 WEST HILL ROAD, 30 metres southeast of /NEWLANDS (OUTSIDE ORDSALL PRIMARY SCHOOL), RETFORD		
Time 15:30				
Weather Fine				
Road Surface Dry				
Street Lighting Daylight				
Speed Limit 30 MPH	SITE DETAILS	SPECIAL SITE CONDITIONS		
Carriageway Single c'way		None		
Lane markings Centre/hazard line				
Junction Detail Not at or within 20m of junction				
Junction Control		CARRIAGEWAY HAZARDS		
2nd Road Number		None		
Pedestrian Facilities No Human control within 50m and No crossing facility within 50m				
VEHICLES INVOLVED 1		CASUALTIES INVOLVED 1		
Veh.No. 1	Vehicle type Car	Cas No 1	Cas Class Pedestrian	Veh ref No 1
Manoeuvre Going ahead other		Severity SERIOUS	Age 6 yrs	Sex Female
Direction from North west to South east	Towing? No	Car Passenger? No	PSV Passenger? No	
Skidded No		Ped Movement Crossing from drivers nearside		
Veh location at impact (restricted lane) On main carriageway		Ped location In c'way crossing elsewhere		
Junct. location of veh. at 1st impact Not at junction		Ped Direction to South west		
Veh left carriageway? Did not leave c'way		School Pupil Other		
Hit object in c'way? None		Roadworker injured No		
Hit object off c'way? None				
First point of impact Nearside				
Drivers age 53 yrs Sex Female	Other veh.hit (ref.) 0			
Foreign vehicle Not foreign	Hit and run No			
Journey purpose Other/Not known	Breath test Negative			

No. 11	District Bassetlaw	<h1>Accident Details</h1>	VRUs	Grid Reference 469733 / 379949
SEVERITY SLIGHT	Ref.No 2B142116		Police Officer Attend: Yes	
Date 18/02/2016 Day Thursday	ROAD U	LOCATION Unclassified Road WEST HILL ROAD/ORDSALL ROAD (NW), at its Junction with Unclassified Road ORDSALL ROAD (E), RETFORD		
Time 11:45				
Weather Fine				
Road Surface Dry				
Street Lighting Daylight				
Speed Limit 30 MPH	SITE DETAILS	SPECIAL SITE CONDITIONS		
Carriageway Single c'way		None		
Lane markings Centre/hazard line				
Junction Detail T or Staggered junction				
Junction Control Give way sign or uncontrolled		CARRIAGEWAY HAZARDS		
2nd Road Number U		None		
Pedestrian Facilities No Human control within 50m and No crossing facility within 50m				
VEHICLES INVOLVED 2		CASUALTIES INVOLVED 2		
Veh.No. 1 Vehicle type Car	Manoeuvre Turning right	Cas No 1 Cas Class Driver or Rider Veh ref No 2	Severity SLIGHT Age 69 yrs Sex Male	
Direction from East to North west	Towing? No	Car Passenger? No	PSV Passenger? No	
Skidded No		Ped Movement Not a pedestrian		
Veh location at impact (restricted lane) On main carriageway		Ped location Not a pedestrian		
Junct. location of veh. at 1st impact Entering main road		Ped Direction to Not a pedestrian		
Veh left carriageway? Did not leave c'way		School Pupil Other		
Hit object in c'way? None		Roadworker injured No		
Hit object off c'way? None				
First point of impact Front		Cas No 2 Cas Class Passenger Veh ref No 2	Severity SLIGHT Age U/K yrs Sex Male	
Drivers age 67 yrs Sex Male Other veh.hit (ref.) 2 Hit and run No		Car Passenger? Front	PSV Passenger? No	
Foreign vehicle Not foreign Breath test Negative		Ped Movement Not a pedestrian		
Journey purpose Commuting to/from work		Ped location Not a pedestrian		
		Ped Direction to Not a pedestrian		
		School Pupil Other		
		Roadworker injured No		
Veh.No. 2 Vehicle type Car	Manoeuvre Going ahead other			
Direction from North west to South east	Towing? No			
Skidded No				
Veh location at impact (restricted lane) On main carriageway				
Junct. location of veh. at 1st impact Mid junction				
Veh left carriageway? Did not leave c'way				
Hit object in c'way? None				
Hit object off c'way? None				
First point of impact Nearside				
Drivers age 69 yrs Sex Male Other veh.hit (ref.) 1 Hit and run No				
Foreign vehicle Not foreign Breath test Negative				
Journey purpose				

No. 12	District Bassetlaw	<h1>Accident Details</h1>	VRUs	Grid Reference 469638 / 380035
SEVERITY SLIGHT	Ref.No 2B084617		Pedestrian	Police Officer Attend: Yes
Date 05/05/2017 Day Friday	ROAD U	LOCATION Unclassified Road ORDSALL ROAD at House Number 97, RETFORD		
Time 16:28				
Weather Fine				
Road Surface Dry				
Street Lighting Daylight				
Speed Limit 30 MPH	SITE DETAILS	SPECIAL SITE CONDITIONS		
Carriageway Single c'way		None		
Lane markings Centre/hazard line				
Junction Detail Not at or within 20m of junction				
Junction Control		CARRIAGEWAY HAZARDS		
2nd Road Number		None		
Pedestrian Facilities No Human control within 50m and No crossing facility within 50m				
VEHICLES INVOLVED 1		CASUALTIES INVOLVED 1		
Veh.No. 1	Vehicle type Car	Cas No 1	Cas Class Pedestrian	Veh ref No 1
Manoeuvre Going ahead other		Severity SLIGHT	Age 12 yrs	Sex Male
Direction from North west to South east	Towing? No	Car Passenger? No	PSV Passenger? No	
Skidded No		Ped Movement Crossing from drivers nearside		
Veh location at impact (restricted lane) On main carriageway		Ped location In c'way crossing elsewhere		
Junct. location of veh. at 1st impact Not at junction		Ped Direction to South west		
Veh left carriageway? Did not leave c'way		School Pupil Yes on way to or from school		
Hit object in c'way? None		Roadworker injured No		
Hit object off c'way? None				
First point of impact Front				
Drivers age 53 yrs Sex Male	Other veh.hit (ref.) 0	Hit and run No		
Foreign vehicle Not foreign		Breath test Not requested		
Journey purpose Other/Not known				

No. 13	District Bassetlaw	<h1>Accident Details</h1>	VRUs	Grid Reference 469603 / 380060
SEVERITY SLIGHT	Ref.No 2B053920		Pedestrian	Police Officer Attend: No - reported over the counter
Date 20/04/2020 Day Monday	ROAD U	LOCATION U/C ORDSALL ROAD at House Number OPP 89, 21 metres southeast of NORTHUMBRIA DRIVE, RETFORD		
Time 18:55				
Weather Fine				
Road Surface Dry				
Street Lighting Daylight				
Speed Limit 30 MPH	SITE DETAILS	SPECIAL SITE CONDITIONS		
Carriageway Single c'way		None		
Lane markings Centre/hazard line				
Junction Detail Not at or within 20m of junction		CARRIAGEWAY HAZARDS		
Junction Control		None		
2nd Road Number				
Pedestrian Facilities No Human control within 50m and No crossing facility within 50m				
VEHICLES INVOLVED 1		CASUALTIES INVOLVED 1		
Veh.No. 1 Vehicle type Car		Cas No 1 Cas Class Pedestrian Veh ref No 1		
Manoeuvre Going ahead other		Severity SLIGHT Age 35 yrs Sex Male		
Direction from South east to North west Towing? No		Car Passenger? No PSV Passenger? No		
Skidded No		Ped Movement Crossing from drivers offside		
Veh location at impact (restricted lane) On main carriageway		Ped location In c'way crossing elsewhere		
Junct. location of veh. at 1st impact Not at junction		Ped Direction to South west		
Veh left carriageway? Did not leave c'way		School Pupil Other		
Hit object in c'way? None		Roadworker injured No		
Hit object off c'way? None				
First point of impact Nearside				
Drivers age 37 yrs Sex Male Other veh.hit (ref.) 0 Hit and run No				
Foreign vehicle Not foreign Breath test Not contacted				
Journey purpose				

No. 14	District Bassetlaw	<h1>Accident Details</h1>	VRUs	Grid Reference 469447 / 380206
SEVERITY SERIOUS	Ref.No 2B068318		Police Officer Attend: Yes	
Date 26/03/2018 Day Monday	ROAD U	LOCATION U/C ORDSALL ROAD, 236 metres southeast of U/C ORDSALL PARK ROAD, RETFORD		
Time 19:56				
Weather Fine				
Road Surface Dry				
Street Lighting Dark/lights lit				
Speed Limit 30 MPH	SITE DETAILS	SPECIAL SITE CONDITIONS		
Carriageway Single c'way		None		
Lane markings Centre/hazard line				
Junction Detail Not at or within 20m of junction				
Junction Control		CARRIAGEWAY HAZARDS		
2nd Road Number		None		
Pedestrian Facilities No Human control within 50m and No crossing facility within 50m				
VEHICLES INVOLVED 2		CASUALTIES INVOLVED 2		
Veh.No. 1 Vehicle type Car	Manoeuvre Going ahead other	Cas No 1 Cas Class Driver or Rider	Veh ref No 1	
Direction from North west to South east	Towing? No	Severity SERIOUS	Age 59 yrs	Sex Male
Skidded No		Car Passenger? No	PSV Passenger? No	
Veh location at impact (restricted lane) On main carriageway		Ped Movement Not a pedestrian		
Junct. location of veh. at 1st impact Not at junction		Ped location Not a pedestrian		
Veh left carriageway? Did not leave c'way		Ped Direction to Not a pedestrian		
Hit object in c'way? None		School Pupil Other		
Hit object off c'way? None		Roadworker injured No		
First point of impact Front		Cas No 2 Cas Class Driver or Rider	Veh ref No 2	
Drivers age 59 yrs Sex Male	Other veh.hit (ref.) 2	Severity SLIGHT	Age 39 yrs	Sex Male
Foreign vehicle Not foreign	Hit and run No	Car Passenger? No	PSV Passenger? No	
Journey purpose Commuting to/from work	Breath test Not requested	Ped Movement Not a pedestrian		
Veh.No. 2 Vehicle type Car	Manoeuvre Going ahead other	Ped location Not a pedestrian		
Direction from South east to North west	Towing? No	Ped Direction to Not a pedestrian		
Skidded No		School Pupil Other		
Veh location at impact (restricted lane) On main carriageway		Roadworker injured No		
Junct. location of veh. at 1st impact Not at junction				
Veh left carriageway? Did not leave c'way				
Hit object in c'way? None				
Hit object off c'way? None				
First point of impact Front				
Drivers age 39 yrs Sex Male	Other veh.hit (ref.) 1			
Foreign vehicle Not foreign	Hit and run No			
Journey purpose Commuting to/from work	Breath test Not requested			

No. 15	District Bassetlaw	<h1>Accident Details</h1>	VRUs	Grid Reference 469318 / 380377
SEVERITY SLIGHT	Ref.No 2B137815		Pedestrian	Police Officer Attend: No - reported over the counter
Date 08/06/2015 Day Monday	ROAD U	LOCATION Unclassified Road ORDSALL ROAD, 21 metres southeast of Unclassified Road ORDSALL PARK ROAD, RETFORD		
Time 08:15				
Weather Other				
Road Surface Dry				
Street Lighting Daylight				
Speed Limit 30 MPH	SITE DETAILS	SPECIAL SITE CONDITIONS		
Carriageway Single c'way		None		
Lane markings Centre/hazard line				
Junction Detail Not at or within 20m of junction		CARRIAGEWAY HAZARDS		
Junction Control		None		
2nd Road Number				
Pedestrian Facilities No Human control within 50m and No crossing facility within 50m				
VEHICLES INVOLVED 1		CASUALTIES INVOLVED 1		
Veh.No. 1	Vehicle type Goods 3.5 - 7.5t	Cas No 1	Cas Class Pedestrian	Veh ref No 1
Manoeuvre Going ahead other		Severity SLIGHT	Age 16 yrs	Sex Male
Direction from South east to North west	Towing? No	Car Passenger? No	PSV Passenger? No	
Skidded No		Ped Movement Unknown or other		
Veh location at impact (restricted lane) On main carriageway		Ped location On footway or verge		
Junct. location of veh. at 1st impact Not at junction		Ped Direction to South west		
Veh left carriageway? Did not leave c'way		School Pupil Yes on way to or from school		
Hit object in c'way? None		Roadworker injured No		
Hit object off c'way? None				
First point of impact Nearside				
Drivers age 48 yrs Sex Male	Other veh.hit (ref.) 0	Hit and run No		
Foreign vehicle Not foreign		Breath test Not contacted		
Journey purpose Journey as part of work				

No. 16	District Bassetlaw	<h1>Accident Details</h1>	VRUs Motorcycle	Grid Reference 469125 / 380649
SEVERITY SERIOUS	Ref.No 2B072117		Police Officer Attend: Yes	
Date 04/02/2017 Day Saturday	ROAD A620	LOCATION A620 BABWORTH ROAD RBT, at its Junction with Unclassified Road ORDSALL ROAD, RETFORD		
Time 11:42				
Weather Fine				
Road Surface Dry				
Street Lighting Daylight				
Speed Limit 40 MPH	SITE DETAILS	SPECIAL SITE CONDITIONS		
Carriageway Roundabout		None		
Lane markings Centre/hazard line				
Junction Detail Mini Roundabout				
Junction Control Give way sign or uncontrolled		CARRIAGEWAY HAZARDS		
2nd Road Number U		None		
Pedestrian Facilities No Human control within 50m and No crossing facility within 50m				
VEHICLES INVOLVED 2		CASUALTIES INVOLVED 1		
Veh.No. 1 Vehicle type M/cycle 50 - 125cc	Manoeuvre Going ahead other	Cas No 1 Cas Class Driver or Rider Veh ref No 1	Severity SERIOUS Age 19 yrs Sex Male	
Direction from North east to South west Towing? No	Skidded No	Car Passenger? No PSV Passenger? No	Ped Movement Not a pedestrian	
Veh location at impact (restricted lane) On main carriageway	Junct. location of veh. at 1st impact Mid junction	Ped location Not a pedestrian	Ped Direction to Not a pedestrian	
Veh left carriageway? Did not leave c'way	Hit object in c'way? None	School Pupil Other	Roadworker injured No	
Hit object off c'way? None	First point of impact Front			
Drivers age 19 yrs Sex Male Other veh.hit (ref.) 2 Hit and run No	Foreign vehicle Not foreign		Breath test Not requested	
Journey purpose				
Veh.No. 2 Vehicle type Car	Manoeuvre Turning right			
Direction from South east to North east Towing? No	Skidded No			
Veh location at impact (restricted lane) On main carriageway	Junct. location of veh. at 1st impact Entering roundabout			
Veh left carriageway? Did not leave c'way	Hit object in c'way? None			
Hit object off c'way? None	First point of impact Offside			
Drivers age 73 yrs Sex Male Other veh.hit (ref.) 1 Hit and run No	Foreign vehicle Not foreign		Breath test Not requested	
Journey purpose				

No. 17	District Bassetlaw	<h1>Accident Details</h1>	VRUs	Grid Reference 469129 / 380651
SEVERITY SLIGHT	Ref.No 2B183215		Police Officer Attend: Yes	
Date 30/07/2015 Day Thursday	ROAD A620	LOCATION A620 BABWORTH ROAD, at its M-RBT Junction with Unclassified Road ORDSALL ROAD, RETFORD		
Time 20:29				
Weather Fine				
Road Surface Dry				
Street Lighting Daylight				
Speed Limit 30 MPH	SITE DETAILS	SPECIAL SITE CONDITIONS		
Carriageway Roundabout		None		
Lane markings Centre/hazard line				
Junction Detail Mini Roundabout				
Junction Control Give way sign or uncontrolled		CARRIAGEWAY HAZARDS		
2nd Road Number U		None		
Pedestrian Facilities No Human control within 50m and No crossing facility within 50m				
VEHICLES INVOLVED 2		CASUALTIES INVOLVED 2		
Veh.No. 1 Vehicle type Car	Manoeuvre Turning right	Cas No 1 Cas Class Driver or Rider Veh ref No 1	Severity SLIGHT Age 19 yrs Sex Female	
Direction from South east to North east	Towing? No	Car Passenger? No	PSV Passenger? No	
Skidded No		Ped Movement	Not a pedestrian	
Veh location at impact (restricted lane) On main carriageway		Ped location	Not a pedestrian	
Junct. location of veh. at 1st impact Entering roundabout		Ped Direction to	Not a pedestrian	
Veh left carriageway? Did not leave c'way		School Pupil	Other	
Hit object in c'way? None		Roadworker injured	No	
Hit object off c'way? None		Cas No 2 Cas Class Driver or Rider Veh ref No 2	Severity SLIGHT Age 29 yrs Sex Male	
First point of impact Front		Car Passenger? No	PSV Passenger? No	
Drivers age 19 yrs Sex Female Other veh.hit (ref.) 2 Hit and run No		Ped Movement	Not a pedestrian	
Foreign vehicle Not foreign Breath test Negative		Ped location	Not a pedestrian	
Journey purpose Journey as part of work		Ped Direction to	Not a pedestrian	
Veh.No. 2 Vehicle type Car	Manoeuvre Going ahead other	School Pupil	Other	
Direction from North east to South west	Towing? No	Roadworker injured	No	
Skidded No				
Veh location at impact (restricted lane) On main carriageway				
Junct. location of veh. at 1st impact Mid junction				
Veh left carriageway? Did not leave c'way				
Hit object in c'way? Bollard/refuge				
Hit object off c'way? None				
First point of impact Nearside				
Drivers age 29 yrs Sex Male Other veh.hit (ref.) 1 Hit and run No				
Foreign vehicle Not foreign Breath test Negative				
Journey purpose Journey as part of work				

No. 18	District Bassetlaw	<h1>Accident Details</h1>	VRUs	Grid Reference 469125 / 380653
SEVERITY SLIGHT	Ref.No 2B082719		Police Officer Attend: Yes	
Date 24/05/2019 Day Friday	ROAD A620	LOCATION A620 BABWORTH ROAD M-RBT, at its Junction with U/C ORDSALL ROAD, RETFORD		
Time 12:40				
Weather Fine				
Road Surface Dry				
Street Lighting Daylight				
Speed Limit 40 MPH	SITE DETAILS	SPECIAL SITE CONDITIONS		
Carriageway Roundabout		None		
Lane markings Centre/hazard line				
Junction Detail Mini Roundabout				
Junction Control Give way sign or uncontrolled		CARRIAGEWAY HAZARDS		
2nd Road Number U		None		
Pedestrian Facilities No Human control within 50m and Central Refuge only				
VEHICLES INVOLVED 2		CASUALTIES INVOLVED 1		
Veh.No. 1 Vehicle type Car	Manoeuvre Turning right	Cas No 1 Cas Class Driver or Rider Veh ref No 2	Severity SLIGHT	Age 20 yrs Sex Female
Direction from South west to South east	Towing? No	Car Passenger? No	PSV Passenger? No	
Skidded No		Ped Movement Not a pedestrian		
Veh location at impact (restricted lane) On main carriageway		Ped location Not a pedestrian		
Junct. location of veh. at 1st impact Mid junction		Ped Direction to Not a pedestrian		
Veh left carriageway? Did not leave c'way		School Pupil Other		
Hit object in c'way? None		Roadworker injured No		
Hit object off c'way? None				
First point of impact Front				
Drivers age 22 yrs Sex Male	Other veh.hit (ref.) 2			
Foreign vehicle Not foreign	Hit and run No			
Journey purpose Commuting to/from work	Breath test Negative			
Veh.No. 2 Vehicle type Car	Manoeuvre Going ahead other			
Direction from North east to South west	Towing? No			
Skidded No				
Veh location at impact (restricted lane) On main carriageway				
Junct. location of veh. at 1st impact Entering roundabout				
Veh left carriageway? Did not leave c'way				
Hit object in c'way? None				
Hit object off c'way? None				
First point of impact Front				
Drivers age 20 yrs Sex Female	Other veh.hit (ref.) 1			
Foreign vehicle Not foreign	Hit and run No			
Journey purpose Commuting to/from work	Breath test Negative			

No. 19	District Bassetlaw	<h1>Accident Details</h1>	VRUs Motorcycle	Grid Reference 469124 / 380655
SEVERITY SLIGHT	Ref.No 2B204718		Police Officer Attend: No - reported over the counter	
Date 13/10/2018 Day Saturday	ROAD A620	LOCATION A620 BABWORTH ROAD M-RBT, at its Junction with U/C ORDSALL ROAD, RETFORD		
Time 08:00				
Weather Fine				
Road Surface Dry				
Street Lighting Daylight				
Speed Limit 40 MPH	SITE DETAILS	SPECIAL SITE CONDITIONS		
Carriageway Roundabout		Oil or diesel		
Lane markings Centre/hazard line				
Junction Detail Mini Roundabout				
Junction Control Give way sign or uncontrolled		CARRIAGEWAY HAZARDS		
2nd Road Number U		None		
Pedestrian Facilities No Human control within 50m and No crossing facility within 50m				
VEHICLES INVOLVED 1		CASUALTIES INVOLVED 1		
Veh.No. 1 Vehicle type M/cycle <= 50cc		Cas No 1 Cas Class Driver or Rider Veh ref No 1		
Manoeuvre Turning right		Severity SLIGHT Age 17 yrs Sex Female		
Direction from South east to North east Towing? No		Car Passenger? No PSV Passenger? No		
Skidded Yes		Ped Movement Not a pedestrian		
Veh location at impact (restricted lane) On main carriageway		Ped location Not a pedestrian		
Junct. location of veh. at 1st impact Entering roundabout		Ped Direction to Not a pedestrian		
Veh left carriageway? Left c'way near-side		School Pupil Other		
Hit object in c'way? None		Roadworker injured No		
Hit object off c'way? None				
First point of impact Offside				
Drivers age 17 yrs Sex Female Other veh.hit (ref.) 0 Hit and run No				
Foreign vehicle Not foreign Breath test Not requested				
Journey purpose				

Appendix E – Concept Access Layout



- KERBING
- EDGING
- WHITE LINING
- VERGE
- INTERNAL LAYOUT TIC



14, Middlefields Lane - Highgate Park, Leamington Spa, Warwickshire CV34 5JL
 Tel: 01927 500000
 Fax: 01927 500001
 Email: info@howardbedford.co.uk
 www.howardbedford.co.uk

HOWARD BEDFORD LTD

LAND TO THE SOUTH OF ODEGALL
 RETYOND

SITE ACCESS
 PRELIMINARY LAYOUT
 4000 CO ROUNDABOUTS

DATE	REV	DESCRIPTION	BY	CHKD
20/11/16	1	DPL SK007		

© Development Planning Limited

Appendix F – TEMPpro Outputs

Appendix G – Committed Development Flows

Thrumpton Lane, Bedford (Final Development)
A52
Lighting Peak Hour
Lighting Peak Hour

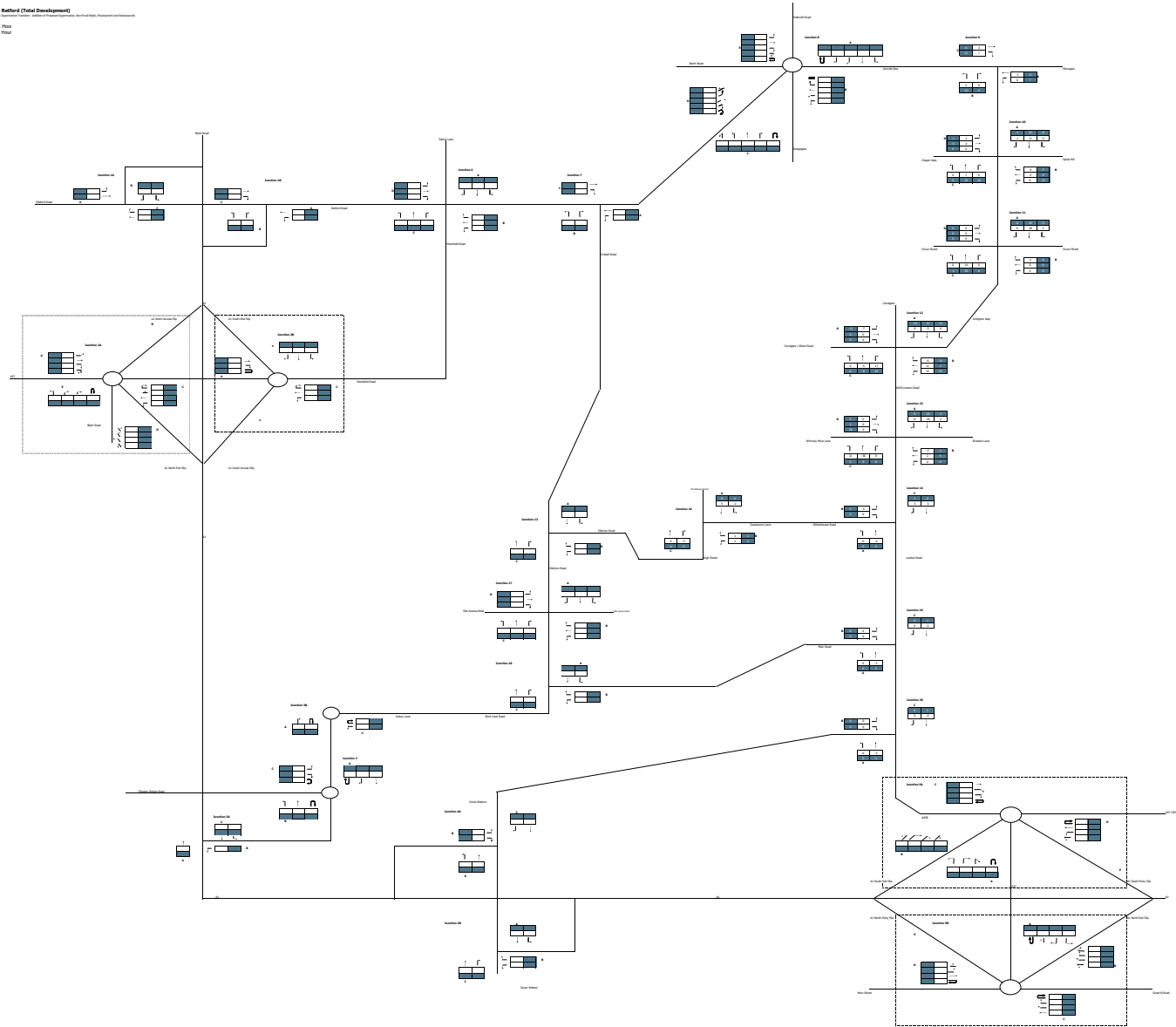

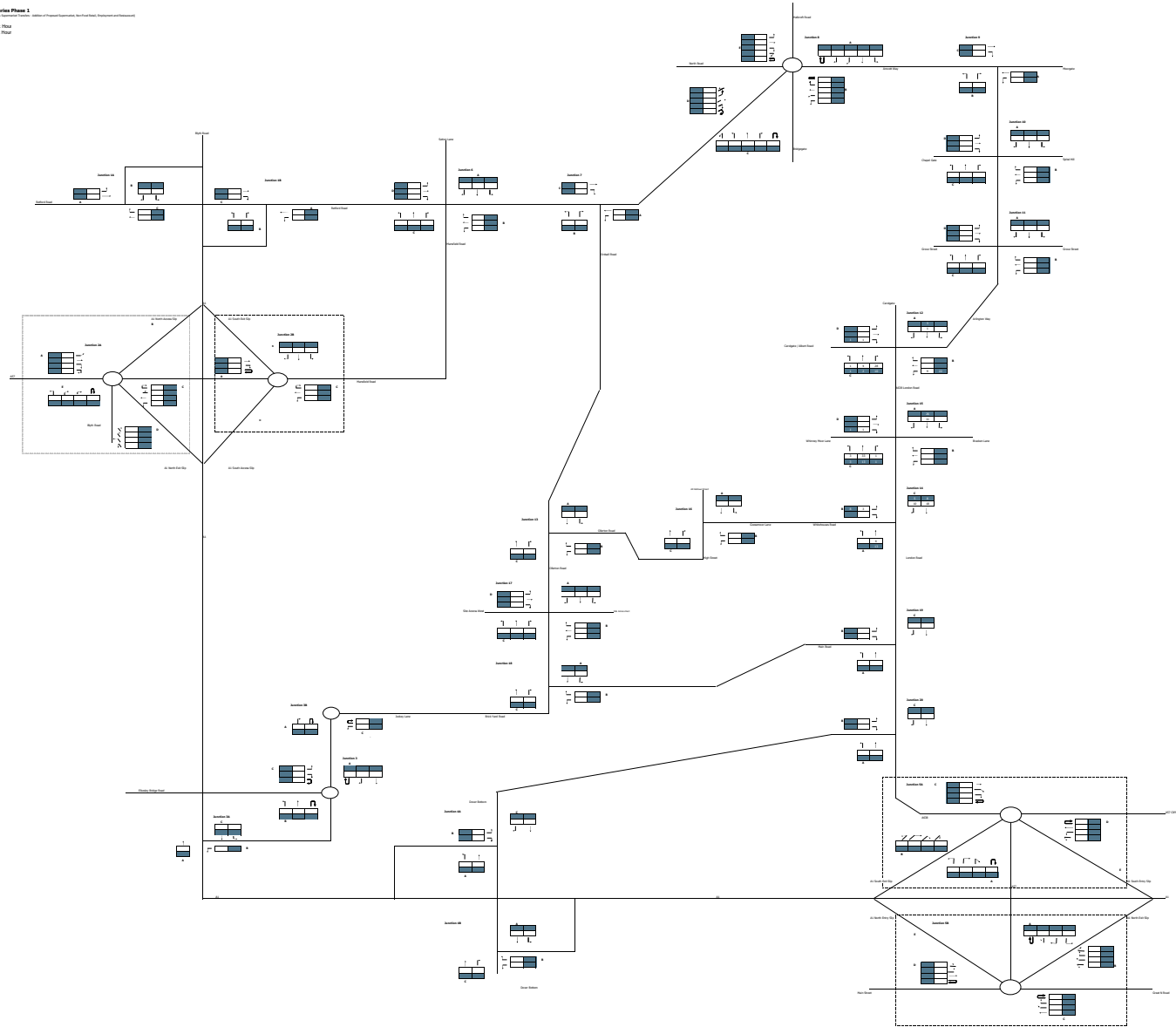

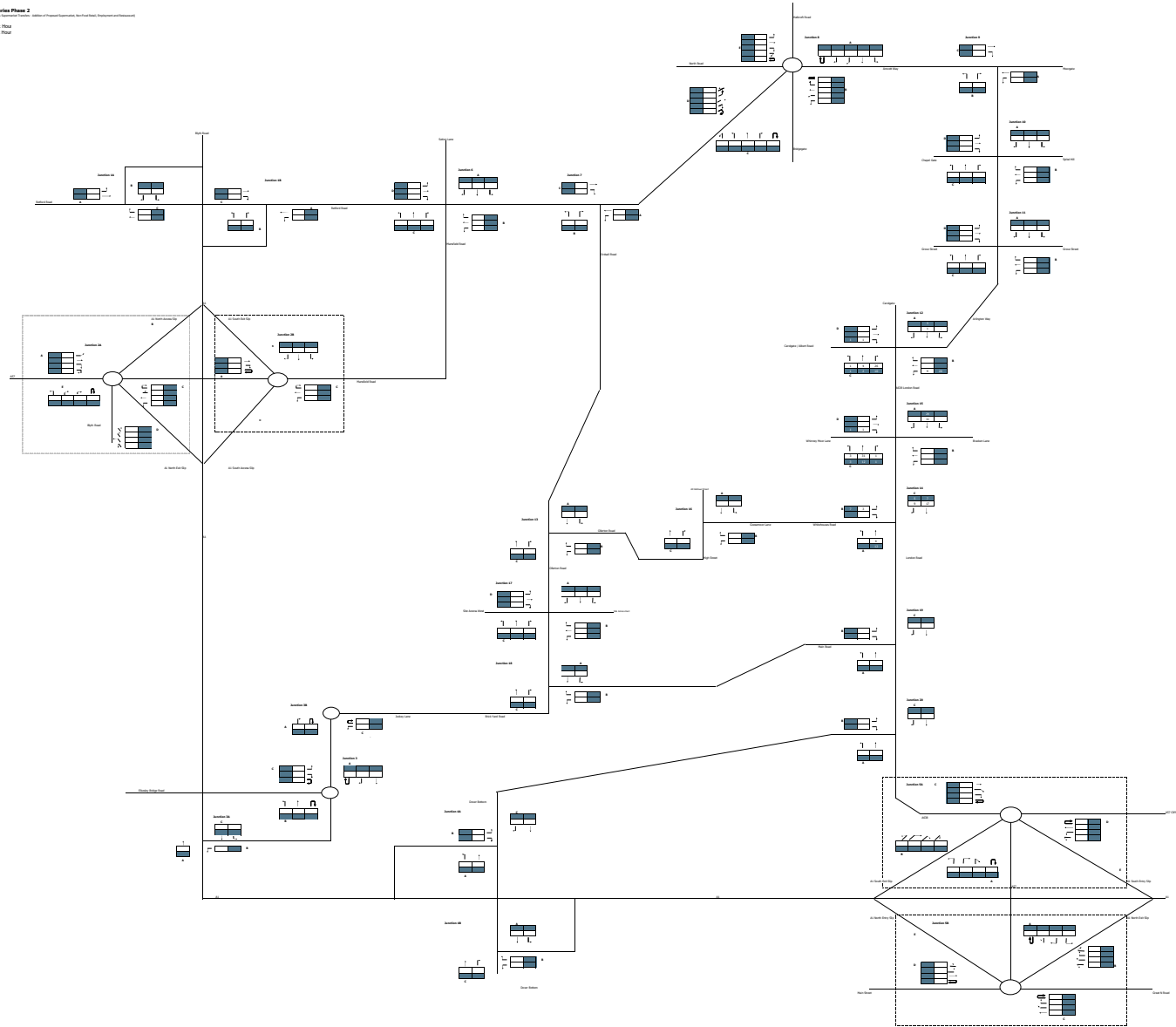

Appendix H – Development Flows for Other Allocations

OTHER POSSIBLE DEVELOPMENT - PEAKS HILL FARM (Vehicle)

2025
Lighting Peak Hour
Lighting Peak Hour

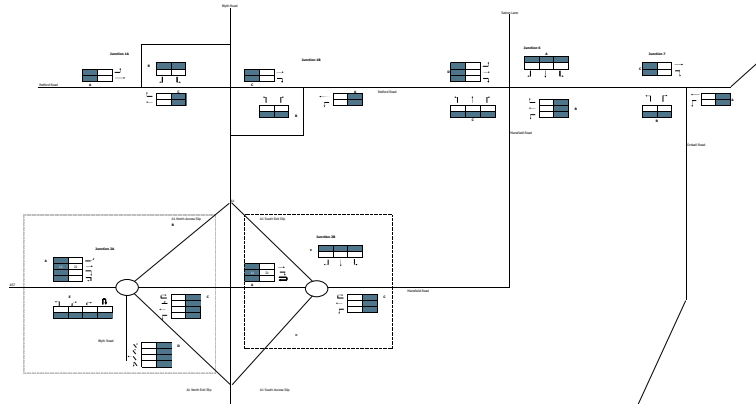

OTHER POSSIBLE DEVELOPMENT - AFLEYHEAD (Vehicle)

AFV
Lighting Peak Hour
Lighting Peak Hour

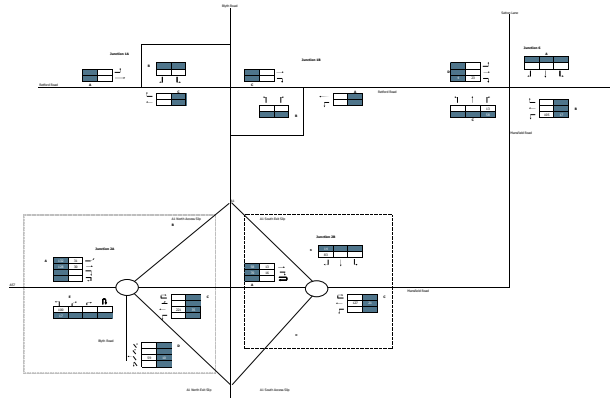

OPTIONAL POSSIBLE DEVELOPMENT - STATION STREET (PCIM)

PCIM
Lighting Peak Hour
Turning Peak Hour

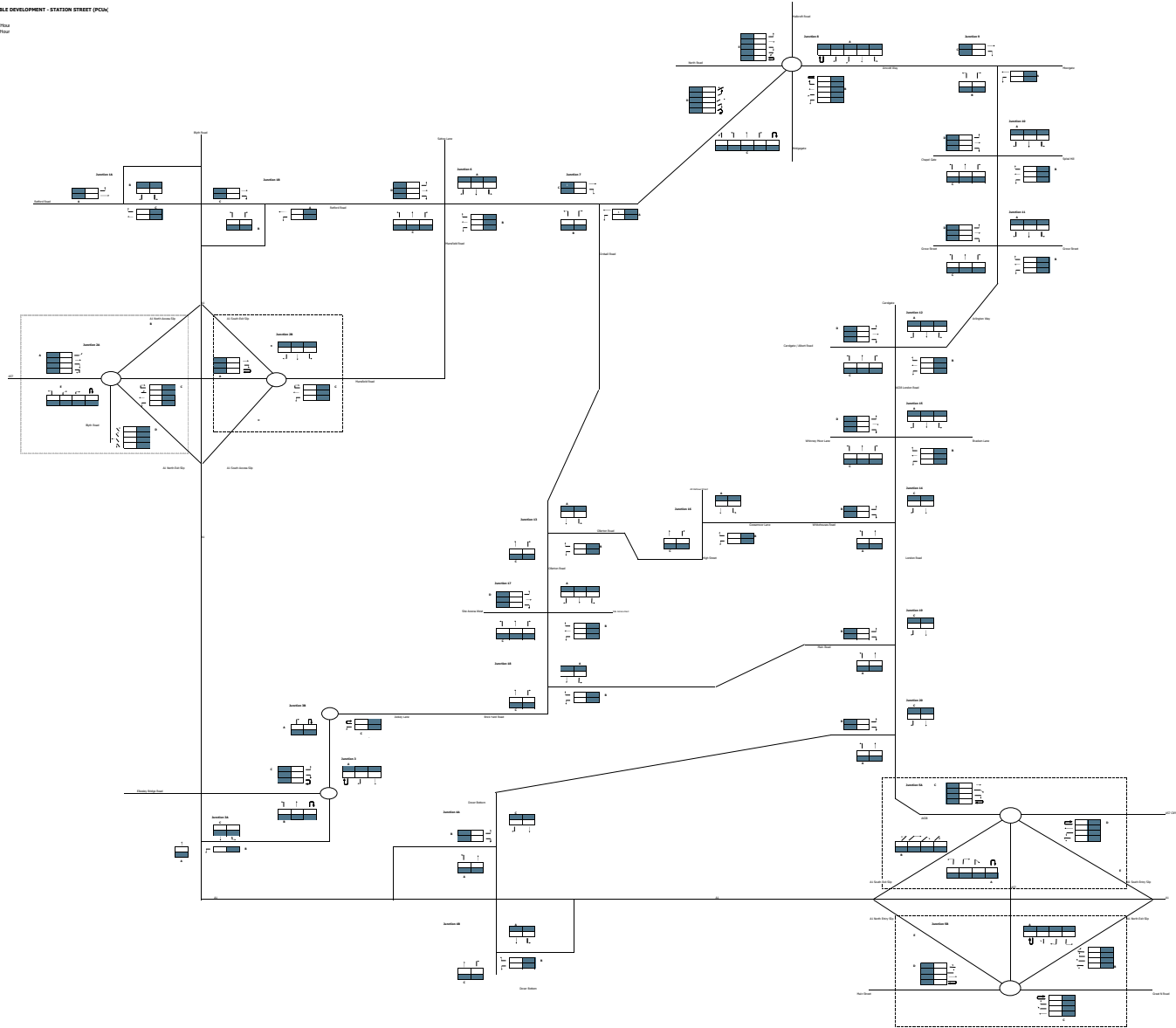

OTHER POSSIBLE DEVELOPMENT - ST MICHAELS (PCU)

PCU
Peak Hour
Peak Hour

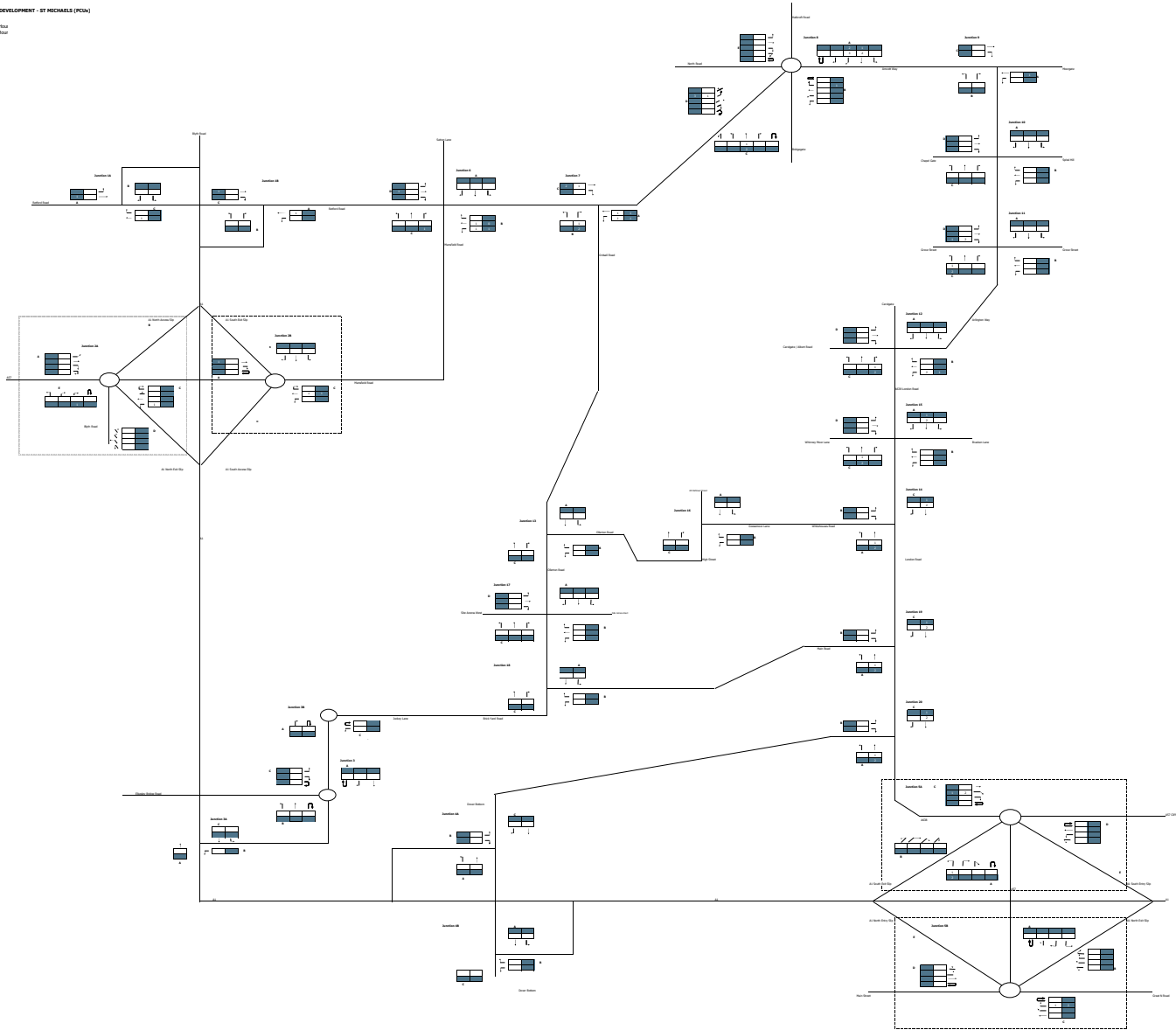

OTHER POSSIBLE DEVELOPMENT - FAIRY GROVE (PCIN)

PCIN
Lighting Peak Hour
Turning Peak Hour

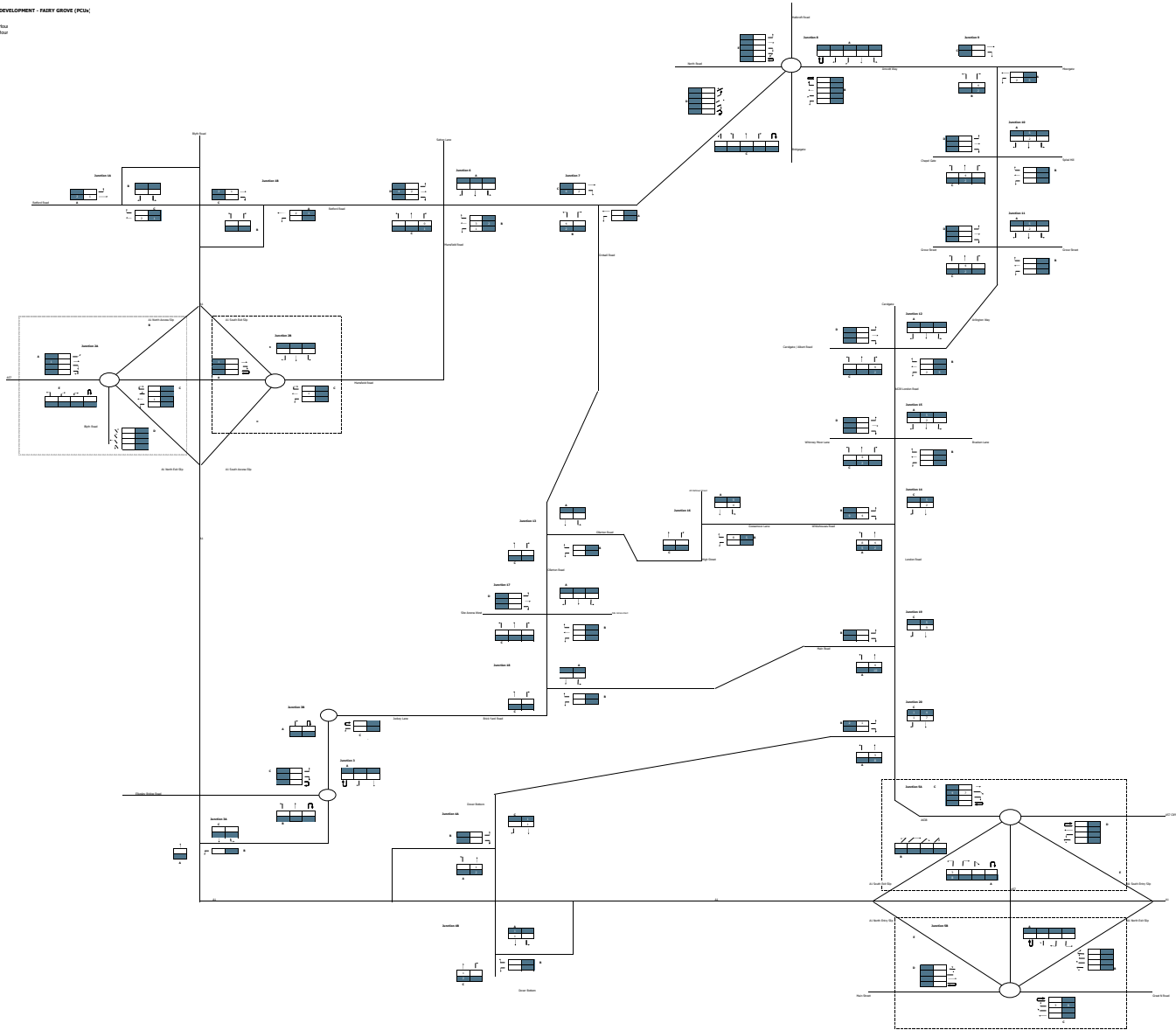

OTHER POSSIBLE DEVELOPMENTS - TOTAL (PCUs)

2025
Lighting Peak Hour
Lighting Peak Hour

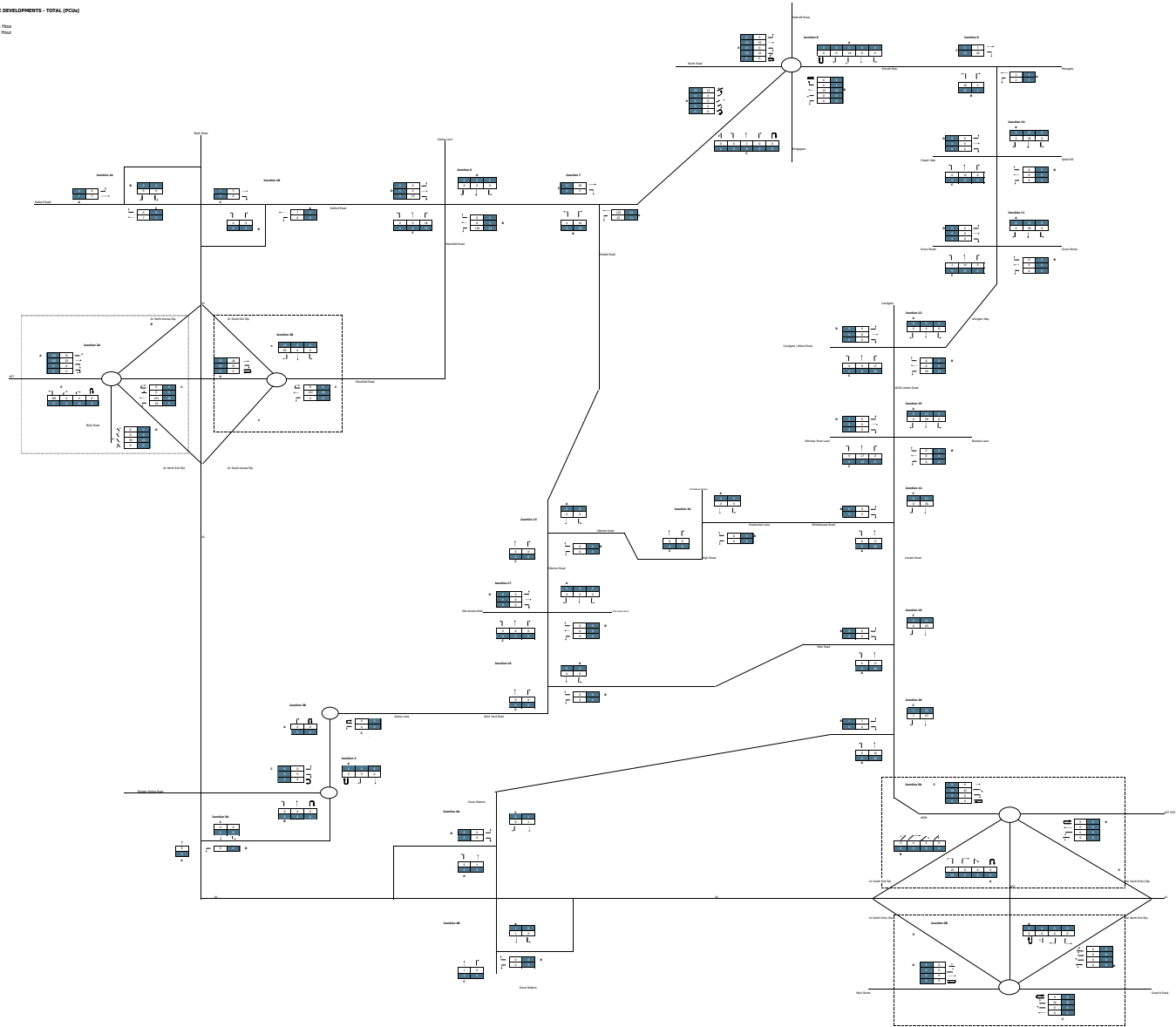

Appendix I – Trip Generation & Distribution

WYG Executive Park, Avalon Way Leicester

Licence No: 705102

Calculation Reference: AUDIT-705102-220124-0114

TRIP RATE CALCULATION SELECTION PARAMETERS:

Land Use : 03 - RESIDENTIAL
 Category : A - HOUSES PRIVATELY OWNED

MULTI-MODAL TOTAL VEHICLESSelected regions and areas:

02 SOUTH EAST
 WS WEST SUSSEX 1 days
04 EAST ANGLIA
 NF NORFOLK 1 days

This section displays the number of survey days per TRICS® sub-region in the selected set

Primary Filtering selection:

This data displays the chosen trip rate parameter and its selected range. Only sites that fall within the parameter range are included in the trip rate calculation.

Parameter: No of Dwellings
 Actual Range: 514 to 918 (units:)
 Range Selected by User: 7 to 1817 (units:)

Parking Spaces Range: All Surveys Included

Parking Spaces per Dwelling Range: All Surveys Included

Bedrooms per Dwelling Range: All Surveys Included

Percentage of dwellings privately owned: All Surveys Included

Public Transport Provision:

Selection by: Include all surveys

Date Range: 01/01/13 to 23/09/21

This data displays the range of survey dates selected. Only surveys that were conducted within this date range are included in the trip rate calculation.

Selected survey days:

Tuesday 1 days
 Wednesday 1 days

This data displays the number of selected surveys by day of the week.

Selected survey types:

Manual count 2 days
 Directional ATC Count 0 days

This data displays the number of manual classified surveys and the number of unclassified ATC surveys, the total adding up to the overall number of surveys in the selected set. Manual surveys are undertaken using staff, whilst ATC surveys are undertaken using machines.

Selected Locations:

Edge of Town 2

This data displays the number of surveys per main location category within the selected set. The main location categories consist of Free Standing, Edge of Town, Suburban Area, Neighbourhood Centre, Edge of Town Centre, Town Centre and Not Known.

Selected Location Sub Categories:

Residential Zone 1
 Out of Town 1

This data displays the number of surveys per location sub-category within the selected set. The location sub-categories consist of Commercial Zone, Industrial Zone, Development Zone, Residential Zone, Retail Zone, Built-Up Zone, Village, Out of Town, High Street and No Sub Category.

WYG Executive Park, Avalon Way Leicester

Licence No: 705102

Secondary Filtering selection:Use Class:

C3 2 days

This data displays the number of surveys per Use Class classification within the selected set. The Use Classes Order 2005 has been used for this purpose, which can be found within the Library module of TRICS®.

Population within 500m Range:

All Surveys Included

Population within 1 mile:

5,001 to 10,000 1 days

10,001 to 15,000 1 days

This data displays the number of selected surveys within stated 1-mile radii of population.

Population within 5 miles:

25,001 to 50,000 1 days

75,001 to 100,000 1 days

This data displays the number of selected surveys within stated 5-mile radii of population.

Car ownership within 5 miles:

1.1 to 1.5 2 days

This data displays the number of selected surveys within stated ranges of average cars owned per residential dwelling, within a radius of 5-miles of selected survey sites.

Travel Plan:

Yes 2 days

This data displays the number of surveys within the selected set that were undertaken at sites with Travel Plans in place, and the number of surveys that were undertaken at sites without Travel Plans.

PTAL Rating:

No PTAL Present 2 days

This data displays the number of selected surveys with PTAL Ratings.

LIST OF SITES relevant to selection parameters

<p>1 NF-03-A-23 SILFIELD ROAD WYMONDHAM</p> <p>Edge of Town Out of Town Total No of Dwellings: 514 Survey date: WEDNESDAY 22/09/21</p>	<p>MIXED HOUSES & FLATS</p>	<p>NORFOLK</p>
<p>2 WS-03-A-11 ELLIS ROAD WEST HORSHAM S BROADBRIDGE HEATH Edge of Town Residential Zone Total No of Dwellings: 918 Survey date: TUESDAY 02/04/19</p>	<p>MIXED HOUSES</p>	<p>WEST SUSSEX</p> <p>Survey Type: MANUAL</p>

This section provides a list of all survey sites and days in the selected set. For each individual survey site, it displays a unique site reference code and site address, the selected trip rate calculation parameter and its value, the day of the week and date of each survey, and whether the survey was a manual classified count or an ATC count.

MANUALLY DESELECTED SITES

Site Ref	Reason for Deselection
CA-03-A-05	as requested by NCC
CA-03-A-07	as requested by NCC
ES-03-A-03	as requested by NCC
ES-03-A-04	as requested by NCC
ES-03-A-05	as requested by NCC
ES-03-A-06	as requested by NCC
HC-03-A-21	as requested by NCC
HC-03-A-22	as requested by NCC
HC-03-A-23	as requested by NCC
HF-03-A-03	as requested by NCC
HF-03-A-04	as requested by NCC
KC-03-A-03	as requested by NCC
KC-03-A-04	as requested by NCC
KC-03-A-05	as requested by NCC
KC-03-A-06	as requested by NCC
KC-03-A-07	as requested by NCC
KC-03-A-08	as requested by NCC
KC-03-A-09	as requested by NCC
NF-03-A-03	as requested by NCC
NF-03-A-25	as requested by NCC
NF-03-A-27	as requested by NCC
NF-03-A-30	as requested by NCC
SC-03-A-04	as requested by NCC
SC-03-A-05	as requested by NCC
SC-03-A-06	as requested by NCC
SF-03-A-05	as requested by NCC
SF-03-A-06	as requested by NCC
SF-03-A-09	as requested by NCC
SF-03-A-10	as requested by NCC
WS-03-A-07	as requested by NCC
WS-03-A-08	as requested by NCC
WS-03-A-10	as requested by NCC
WS-03-A-12	as requested by NCC
WS-03-A-13	as requested by NCC

WYG Executive Park, Avalon Way Leicester

Licence No: 705102

TRIP RATE for Land Use 03 - RESIDENTIAL/A - HOUSES PRIVATELY OWNED

MULTI-MODAL TOTAL VEHICLES

Calculation factor: **1 DWELLS**

BOLD print indicates peak (busiest) period

Total People to Total Vehicles ratio (all time periods and directions): 1.57

Time Range	ARRIVALS			DEPARTURES			TOTALS		
	No. Days	Ave. DWELLS	Trip Rate	No. Days	Ave. DWELLS	Trip Rate	No. Days	Ave. DWELLS	Trip Rate
00:00 - 01:00									
01:00 - 02:00									
02:00 - 03:00									
03:00 - 04:00									
04:00 - 05:00									
05:00 - 06:00									
06:00 - 07:00									
07:00 - 08:00	2	716	0.067	2	716	0.328	2	716	0.395
08:00 - 09:00	2	716	0.160	2	716	0.441	2	716	0.601
09:00 - 10:00	2	716	0.142	2	716	0.151	2	716	0.293
10:00 - 11:00	2	716	0.110	2	716	0.128	2	716	0.238
11:00 - 12:00	2	716	0.116	2	716	0.135	2	716	0.251
12:00 - 13:00	2	716	0.131	2	716	0.126	2	716	0.257
13:00 - 14:00	2	716	0.142	2	716	0.145	2	716	0.287
14:00 - 15:00	2	716	0.138	2	716	0.183	2	716	0.321
15:00 - 16:00	2	716	0.264	2	716	0.173	2	716	0.437
16:00 - 17:00	2	716	0.302	2	716	0.163	2	716	0.465
17:00 - 18:00	2	716	0.407	2	716	0.179	2	716	0.586
18:00 - 19:00	2	716	0.329	2	716	0.180	2	716	0.509
19:00 - 20:00									
20:00 - 21:00									
21:00 - 22:00									
22:00 - 23:00									
23:00 - 24:00									
Total Rates:			2.308			2.332			4.640

This section displays the trip rate results based on the selected set of surveys and the selected count type (shown just above the table). It is split by three main columns, representing arrivals trips, departures trips, and total trips (arrivals plus departures). Within each of these main columns are three sub-columns. These display the number of survey days where count data is included (per time period), the average value of the selected trip rate calculation parameter (per time period), and the trip rate result (per time period). Total trip rates (the sum of the column) are also displayed at the foot of the table.

To obtain a trip rate, the average (mean) trip rate parameter value (TRP) is first calculated for all selected survey days that have count data available for the stated time period. The average (mean) number of arrivals, departures or totals (whichever applies) is also calculated (COUNT) for all selected survey days that have count data available for the stated time period. Then, the average count is divided by the average trip rate parameter value, and multiplied by the stated calculation factor (shown just above the table and abbreviated here as FACT). So, the method is: COUNT/TRP*FACT. Trip rates are then rounded to 3 decimal places.

The survey data, graphs and all associated supporting information, contained within the TRICS Database are published by TRICS Consortium Limited ("the Company") and the Company claims copyright and database rights in this published work. The Company authorises those who possess a current TRICS licence to access the TRICS Database and copy the data contained within the TRICS Database for the licence holders' use only. Any resulting copy must retain all copyrights and other proprietary notices, and any disclaimer contained thereon.

The Company accepts no responsibility for loss which may arise from reliance on data contained in the TRICS Database. [No warranty of any kind, express or implied, is made as to the data contained in the TRICS Database.]

Parameter summary

Trip rate parameter range selected: 514 - 918 (units:)
 Survey date range: 01/01/13 - 23/09/21
 Number of weekdays (Monday-Friday): 2
 Number of Saturdays: 0
 Number of Sundays: 0
 Surveys automatically removed from selection: 13
 Surveys manually removed from selection: 34

This section displays a quick summary of some of the data filtering selections made by the TRICS® user. The trip rate calculation parameter range of all selected surveys is displayed first, followed by the range of minimum and maximum survey dates selected by the user. Then, the total number of selected weekdays and weekend days in the selected set of surveys are shown. Finally, the number of survey days that have been manually removed from the selected set outside of the standard filtering procedure are displayed.

WYG Executive Park, Avalon Way Leicester

Licence No: 705102

TRIP RATE for Land Use 03 - RESIDENTIAL/A - HOUSES PRIVATELY OWNED

MULTI-MODAL TAXIS

Calculation factor: 1 DWELLS

BOLD print indicates peak (busiest) period

Time Range	ARRIVALS			DEPARTURES			TOTALS		
	No. Days	Ave. DWELLS	Trip Rate	No. Days	Ave. DWELLS	Trip Rate	No. Days	Ave. DWELLS	Trip Rate
00:00 - 01:00									
01:00 - 02:00									
02:00 - 03:00									
03:00 - 04:00									
04:00 - 05:00									
05:00 - 06:00									
06:00 - 07:00									
07:00 - 08:00	2	716	0.001	2	716	0.002	2	716	0.003
08:00 - 09:00	2	716	0.006	2	716	0.007	2	716	0.013
09:00 - 10:00	2	716	0.001	2	716	0.001	2	716	0.002
10:00 - 11:00	2	716	0.000	2	716	0.000	2	716	0.000
11:00 - 12:00	2	716	0.000	2	716	0.000	2	716	0.000
12:00 - 13:00	2	716	0.000	2	716	0.000	2	716	0.000
13:00 - 14:00	2	716	0.000	2	716	0.000	2	716	0.000
14:00 - 15:00	2	716	0.001	2	716	0.001	2	716	0.002
15:00 - 16:00	2	716	0.004	2	716	0.003	2	716	0.007
16:00 - 17:00	2	716	0.002	2	716	0.002	2	716	0.004
17:00 - 18:00	2	716	0.000	2	716	0.001	2	716	0.001
18:00 - 19:00	2	716	0.001	2	716	0.001	2	716	0.002
19:00 - 20:00									
20:00 - 21:00									
21:00 - 22:00									
22:00 - 23:00									
23:00 - 24:00									
Total Rates:			0.016			0.018			0.034

This section displays the trip rate results based on the selected set of surveys and the selected count type (shown just above the table). It is split by three main columns, representing arrivals trips, departures trips, and total trips (arrivals plus departures). Within each of these main columns are three sub-columns. These display the number of survey days where count data is included (per time period), the average value of the selected trip rate calculation parameter (per time period), and the trip rate result (per time period). Total trip rates (the sum of the column) are also displayed at the foot of the table.

To obtain a trip rate, the average (mean) trip rate parameter value (TRP) is first calculated for all selected survey days that have count data available for the stated time period. The average (mean) number of arrivals, departures or totals (whichever applies) is also calculated (COUNT) for all selected survey days that have count data available for the stated time period. Then, the average count is divided by the average trip rate parameter value, and multiplied by the stated calculation factor (shown just above the table and abbreviated here as FACT). So, the method is: COUNT/TRP*FACT. Trip rates are then rounded to 3 decimal places.

WYG Executive Park, Avalon Way Leicester

Licence No: 705102

TRIP RATE for Land Use 03 - RESIDENTIAL/A - HOUSES PRIVATELY OWNED

MULTI-MODAL OGVS

Calculation factor: 1 DWELLS

BOLD print indicates peak (busiest) period

Time Range	ARRIVALS			DEPARTURES			TOTALS		
	No. Days	Ave. DWELLS	Trip Rate	No. Days	Ave. DWELLS	Trip Rate	No. Days	Ave. DWELLS	Trip Rate
00:00 - 01:00									
01:00 - 02:00									
02:00 - 03:00									
03:00 - 04:00									
04:00 - 05:00									
05:00 - 06:00									
06:00 - 07:00									
07:00 - 08:00	2	716	0.000	2	716	0.000	2	716	0.000
08:00 - 09:00	2	716	0.000	2	716	0.000	2	716	0.000
09:00 - 10:00	2	716	0.001	2	716	0.001	2	716	0.002
10:00 - 11:00	2	716	0.001	2	716	0.001	2	716	0.002
11:00 - 12:00	2	716	0.001	2	716	0.002	2	716	0.003
12:00 - 13:00	2	716	0.000	2	716	0.000	2	716	0.000
13:00 - 14:00	2	716	0.000	2	716	0.000	2	716	0.000
14:00 - 15:00	2	716	0.000	2	716	0.000	2	716	0.000
15:00 - 16:00	2	716	0.001	2	716	0.000	2	716	0.001
16:00 - 17:00	2	716	0.000	2	716	0.001	2	716	0.001
17:00 - 18:00	2	716	0.000	2	716	0.000	2	716	0.000
18:00 - 19:00	2	716	0.000	2	716	0.000	2	716	0.000
19:00 - 20:00									
20:00 - 21:00									
21:00 - 22:00									
22:00 - 23:00									
23:00 - 24:00									
Total Rates:			0.004			0.005			0.009

This section displays the trip rate results based on the selected set of surveys and the selected count type (shown just above the table). It is split by three main columns, representing arrivals trips, departures trips, and total trips (arrivals plus departures). Within each of these main columns are three sub-columns. These display the number of survey days where count data is included (per time period), the average value of the selected trip rate calculation parameter (per time period), and the trip rate result (per time period). Total trip rates (the sum of the column) are also displayed at the foot of the table.

To obtain a trip rate, the average (mean) trip rate parameter value (TRP) is first calculated for all selected survey days that have count data available for the stated time period. The average (mean) number of arrivals, departures or totals (whichever applies) is also calculated (COUNT) for all selected survey days that have count data available for the stated time period. Then, the average count is divided by the average trip rate parameter value, and multiplied by the stated calculation factor (shown just above the table and abbreviated here as FACT). So, the method is: COUNT/TRP*FACT. Trip rates are then rounded to 3 decimal places.

WYG Executive Park, Avalon Way Leicester

Licence No: 705102

TRIP RATE for Land Use 03 - RESIDENTIAL/A - HOUSES PRIVATELY OWNED

MULTI-MODAL PSVS

Calculation factor: 1 DWELLS

BOLD print indicates peak (busiest) period

Time Range	ARRIVALS			DEPARTURES			TOTALS		
	No. Days	Ave. DWELLS	Trip Rate	No. Days	Ave. DWELLS	Trip Rate	No. Days	Ave. DWELLS	Trip Rate
00:00 - 01:00									
01:00 - 02:00									
02:00 - 03:00									
03:00 - 04:00									
04:00 - 05:00									
05:00 - 06:00									
06:00 - 07:00									
07:00 - 08:00	2	716	0.000	2	716	0.000	2	716	0.000
08:00 - 09:00	2	716	0.002	2	716	0.001	2	716	0.003
09:00 - 10:00	2	716	0.000	2	716	0.001	2	716	0.001
10:00 - 11:00	2	716	0.000	2	716	0.000	2	716	0.000
11:00 - 12:00	2	716	0.000	2	716	0.000	2	716	0.000
12:00 - 13:00	2	716	0.000	2	716	0.000	2	716	0.000
13:00 - 14:00	2	716	0.000	2	716	0.000	2	716	0.000
14:00 - 15:00	2	716	0.000	2	716	0.000	2	716	0.000
15:00 - 16:00	2	716	0.001	2	716	0.001	2	716	0.002
16:00 - 17:00	2	716	0.001	2	716	0.001	2	716	0.002
17:00 - 18:00	2	716	0.000	2	716	0.000	2	716	0.000
18:00 - 19:00	2	716	0.000	2	716	0.000	2	716	0.000
19:00 - 20:00									
20:00 - 21:00									
21:00 - 22:00									
22:00 - 23:00									
23:00 - 24:00									
Total Rates:			0.004			0.004			0.008

This section displays the trip rate results based on the selected set of surveys and the selected count type (shown just above the table). It is split by three main columns, representing arrivals trips, departures trips, and total trips (arrivals plus departures). Within each of these main columns are three sub-columns. These display the number of survey days where count data is included (per time period), the average value of the selected trip rate calculation parameter (per time period), and the trip rate result (per time period). Total trip rates (the sum of the column) are also displayed at the foot of the table.

To obtain a trip rate, the average (mean) trip rate parameter value (TRP) is first calculated for all selected survey days that have count data available for the stated time period. The average (mean) number of arrivals, departures or totals (whichever applies) is also calculated (COUNT) for all selected survey days that have count data available for the stated time period. Then, the average count is divided by the average trip rate parameter value, and multiplied by the stated calculation factor (shown just above the table and abbreviated here as FACT). So, the method is: COUNT/TRP*FACT. Trip rates are then rounded to 3 decimal places.

WYG Executive Park, Avalon Way Leicester

Licence No: 705102

TRIP RATE for Land Use 03 - RESIDENTIAL/A - HOUSES PRIVATELY OWNED

MULTI-MODAL CYCLISTS

Calculation factor: **1 DWELLS**

BOLD print indicates peak (busiest) period

Time Range	ARRIVALS			DEPARTURES			TOTALS		
	No. Days	Ave. DWELLS	Trip Rate	No. Days	Ave. DWELLS	Trip Rate	No. Days	Ave. DWELLS	Trip Rate
00:00 - 01:00									
01:00 - 02:00									
02:00 - 03:00									
03:00 - 04:00									
04:00 - 05:00									
05:00 - 06:00									
06:00 - 07:00									
07:00 - 08:00	2	716	0.003	2	716	0.009	2	716	0.012
08:00 - 09:00	2	716	0.004	2	716	0.022	2	716	0.026
09:00 - 10:00	2	716	0.003	2	716	0.003	2	716	0.006
10:00 - 11:00	2	716	0.002	2	716	0.001	2	716	0.003
11:00 - 12:00	2	716	0.002	2	716	0.001	2	716	0.003
12:00 - 13:00	2	716	0.001	2	716	0.002	2	716	0.003
13:00 - 14:00	2	716	0.001	2	716	0.001	2	716	0.002
14:00 - 15:00	2	716	0.003	2	716	0.001	2	716	0.004
15:00 - 16:00	2	716	0.012	2	716	0.002	2	716	0.014
16:00 - 17:00	2	716	0.010	2	716	0.006	2	716	0.016
17:00 - 18:00	2	716	0.016	2	716	0.007	2	716	0.023
18:00 - 19:00	2	716	0.013	2	716	0.009	2	716	0.022
19:00 - 20:00									
20:00 - 21:00									
21:00 - 22:00									
22:00 - 23:00									
23:00 - 24:00									
Total Rates:			0.070			0.064			0.134

This section displays the trip rate results based on the selected set of surveys and the selected count type (shown just above the table). It is split by three main columns, representing arrivals trips, departures trips, and total trips (arrivals plus departures). Within each of these main columns are three sub-columns. These display the number of survey days where count data is included (per time period), the average value of the selected trip rate calculation parameter (per time period), and the trip rate result (per time period). Total trip rates (the sum of the column) are also displayed at the foot of the table.

To obtain a trip rate, the average (mean) trip rate parameter value (TRP) is first calculated for all selected survey days that have count data available for the stated time period. The average (mean) number of arrivals, departures or totals (whichever applies) is also calculated (COUNT) for all selected survey days that have count data available for the stated time period. Then, the average count is divided by the average trip rate parameter value, and multiplied by the stated calculation factor (shown just above the table and abbreviated here as FACT). So, the method is: COUNT/TRP*FACT. Trip rates are then rounded to 3 decimal places.

WYG Executive Park, Avalon Way Leicester

Licence No: 705102

TRIP RATE for Land Use 03 - RESIDENTIAL/A - HOUSES PRIVATELY OWNED

MULTI-MODAL VEHICLE OCCUPANTS

Calculation factor: **1 DWELLS**

BOLD print indicates peak (busiest) period

Time Range	ARRIVALS			DEPARTURES			TOTALS		
	No. Days	Ave. DWELLS	Trip Rate	No. Days	Ave. DWELLS	Trip Rate	No. Days	Ave. DWELLS	Trip Rate
00:00 - 01:00									
01:00 - 02:00									
02:00 - 03:00									
03:00 - 04:00									
04:00 - 05:00									
05:00 - 06:00									
06:00 - 07:00									
07:00 - 08:00	2	716	0.075	2	716	0.414	2	716	0.489
08:00 - 09:00	2	716	0.175	2	716	0.705	2	716	0.880
09:00 - 10:00	2	716	0.159	2	716	0.170	2	716	0.329
10:00 - 11:00	2	716	0.137	2	716	0.160	2	716	0.297
11:00 - 12:00	2	716	0.142	2	716	0.166	2	716	0.308
12:00 - 13:00	2	716	0.156	2	716	0.143	2	716	0.299
13:00 - 14:00	2	716	0.175	2	716	0.171	2	716	0.346
14:00 - 15:00	2	716	0.172	2	716	0.213	2	716	0.385
15:00 - 16:00	2	716	0.449	2	716	0.205	2	716	0.654
16:00 - 17:00	2	716	0.435	2	716	0.223	2	716	0.658
17:00 - 18:00	2	716	0.559	2	716	0.249	2	716	0.808
18:00 - 19:00	2	716	0.443	2	716	0.257	2	716	0.700
19:00 - 20:00									
20:00 - 21:00									
21:00 - 22:00									
22:00 - 23:00									
23:00 - 24:00									
Total Rates:			3.077			3.076			6.153

This section displays the trip rate results based on the selected set of surveys and the selected count type (shown just above the table). It is split by three main columns, representing arrivals trips, departures trips, and total trips (arrivals plus departures). Within each of these main columns are three sub-columns. These display the number of survey days where count data is included (per time period), the average value of the selected trip rate calculation parameter (per time period), and the trip rate result (per time period). Total trip rates (the sum of the column) are also displayed at the foot of the table.

To obtain a trip rate, the average (mean) trip rate parameter value (TRP) is first calculated for all selected survey days that have count data available for the stated time period. The average (mean) number of arrivals, departures or totals (whichever applies) is also calculated (COUNT) for all selected survey days that have count data available for the stated time period. Then, the average count is divided by the average trip rate parameter value, and multiplied by the stated calculation factor (shown just above the table and abbreviated here as FACT). So, the method is: COUNT/TRP*FACT. Trip rates are then rounded to 3 decimal places.

WYG Executive Park, Avalon Way Leicester

Licence No: 705102

TRIP RATE for Land Use 03 - RESIDENTIAL/A - HOUSES PRIVATELY OWNED

MULTI-MODAL PEDESTRIANS

Calculation factor: 1 DWELLS

BOLD print indicates peak (busiest) period

Time Range	ARRIVALS			DEPARTURES			TOTALS		
	No. Days	Ave. DWELLS	Trip Rate	No. Days	Ave. DWELLS	Trip Rate	No. Days	Ave. DWELLS	Trip Rate
00:00 - 01:00									
01:00 - 02:00									
02:00 - 03:00									
03:00 - 04:00									
04:00 - 05:00									
05:00 - 06:00									
06:00 - 07:00									
07:00 - 08:00	2	716	0.020	2	716	0.045	2	716	0.065
08:00 - 09:00	2	716	0.041	2	716	0.152	2	716	0.193
09:00 - 10:00	2	716	0.024	2	716	0.018	2	716	0.042
10:00 - 11:00	2	716	0.020	2	716	0.022	2	716	0.042
11:00 - 12:00	2	716	0.015	2	716	0.013	2	716	0.028
12:00 - 13:00	2	716	0.018	2	716	0.017	2	716	0.035
13:00 - 14:00	2	716	0.015	2	716	0.022	2	716	0.037
14:00 - 15:00	2	716	0.027	2	716	0.021	2	716	0.048
15:00 - 16:00	2	716	0.119	2	716	0.032	2	716	0.151
16:00 - 17:00	2	716	0.031	2	716	0.010	2	716	0.041
17:00 - 18:00	2	716	0.038	2	716	0.052	2	716	0.090
18:00 - 19:00	2	716	0.058	2	716	0.052	2	716	0.110
19:00 - 20:00									
20:00 - 21:00									
21:00 - 22:00									
22:00 - 23:00									
23:00 - 24:00									
Total Rates:			0.426			0.456			0.882

This section displays the trip rate results based on the selected set of surveys and the selected count type (shown just above the table). It is split by three main columns, representing arrivals trips, departures trips, and total trips (arrivals plus departures). Within each of these main columns are three sub-columns. These display the number of survey days where count data is included (per time period), the average value of the selected trip rate calculation parameter (per time period), and the trip rate result (per time period). Total trip rates (the sum of the column) are also displayed at the foot of the table.

To obtain a trip rate, the average (mean) trip rate parameter value (TRP) is first calculated for all selected survey days that have count data available for the stated time period. The average (mean) number of arrivals, departures or totals (whichever applies) is also calculated (COUNT) for all selected survey days that have count data available for the stated time period. Then, the average count is divided by the average trip rate parameter value, and multiplied by the stated calculation factor (shown just above the table and abbreviated here as FACT). So, the method is: COUNT/TRP*FACT. Trip rates are then rounded to 3 decimal places.

WYG Executive Park, Avalon Way Leicester

Licence No: 705102

TRIP RATE for Land Use 03 - RESIDENTIAL/A - HOUSES PRIVATELY OWNED

MULTI-MODAL BUS/TRAM PASSENGERS

Calculation factor: 1 DWELLS

BOLD print indicates peak (busiest) period

Time Range	ARRIVALS			DEPARTURES			TOTALS		
	No. Days	Ave. DWELLS	Trip Rate	No. Days	Ave. DWELLS	Trip Rate	No. Days	Ave. DWELLS	Trip Rate
00:00 - 01:00									
01:00 - 02:00									
02:00 - 03:00									
03:00 - 04:00									
04:00 - 05:00									
05:00 - 06:00									
06:00 - 07:00									
07:00 - 08:00	2	716	0.003	2	716	0.027	2	716	0.030
08:00 - 09:00	2	716	0.000	2	716	0.004	2	716	0.004
09:00 - 10:00	2	716	0.001	2	716	0.003	2	716	0.004
10:00 - 11:00	2	716	0.001	2	716	0.003	2	716	0.004
11:00 - 12:00	2	716	0.002	2	716	0.006	2	716	0.008
12:00 - 13:00	2	716	0.001	2	716	0.003	2	716	0.004
13:00 - 14:00	2	716	0.003	2	716	0.001	2	716	0.004
14:00 - 15:00	2	716	0.005	2	716	0.003	2	716	0.008
15:00 - 16:00	2	716	0.013	2	716	0.003	2	716	0.016
16:00 - 17:00	2	716	0.009	2	716	0.000	2	716	0.009
17:00 - 18:00	2	716	0.006	2	716	0.001	2	716	0.007
18:00 - 19:00	2	716	0.008	2	716	0.000	2	716	0.008
19:00 - 20:00									
20:00 - 21:00									
21:00 - 22:00									
22:00 - 23:00									
23:00 - 24:00									
Total Rates:			0.052			0.054			0.106

This section displays the trip rate results based on the selected set of surveys and the selected count type (shown just above the table). It is split by three main columns, representing arrivals trips, departures trips, and total trips (arrivals plus departures). Within each of these main columns are three sub-columns. These display the number of survey days where count data is included (per time period), the average value of the selected trip rate calculation parameter (per time period), and the trip rate result (per time period). Total trip rates (the sum of the column) are also displayed at the foot of the table.

To obtain a trip rate, the average (mean) trip rate parameter value (TRP) is first calculated for all selected survey days that have count data available for the stated time period. The average (mean) number of arrivals, departures or totals (whichever applies) is also calculated (COUNT) for all selected survey days that have count data available for the stated time period. Then, the average count is divided by the average trip rate parameter value, and multiplied by the stated calculation factor (shown just above the table and abbreviated here as FACT). So, the method is: COUNT/TRP*FACT. Trip rates are then rounded to 3 decimal places.

WYG Executive Park, Avalon Way Leicester

Licence No: 705102

TRIP RATE for Land Use 03 - RESIDENTIAL/A - HOUSES PRIVATELY OWNED

MULTI-MODAL TOTAL RAIL PASSENGERS

Calculation factor: 1 DWELLS

BOLD print indicates peak (busiest) period

Time Range	ARRIVALS			DEPARTURES			TOTALS		
	No. Days	Ave. DWELLS	Trip Rate	No. Days	Ave. DWELLS	Trip Rate	No. Days	Ave. DWELLS	Trip Rate
00:00 - 01:00									
01:00 - 02:00									
02:00 - 03:00									
03:00 - 04:00									
04:00 - 05:00									
05:00 - 06:00									
06:00 - 07:00									
07:00 - 08:00	2	716	0.000	2	716	0.002	2	716	0.002
08:00 - 09:00	2	716	0.000	2	716	0.001	2	716	0.001
09:00 - 10:00	2	716	0.000	2	716	0.002	2	716	0.002
10:00 - 11:00	2	716	0.000	2	716	0.000	2	716	0.000
11:00 - 12:00	2	716	0.000	2	716	0.000	2	716	0.000
12:00 - 13:00	2	716	0.001	2	716	0.000	2	716	0.001
13:00 - 14:00	2	716	0.000	2	716	0.000	2	716	0.000
14:00 - 15:00	2	716	0.001	2	716	0.000	2	716	0.001
15:00 - 16:00	2	716	0.000	2	716	0.000	2	716	0.000
16:00 - 17:00	2	716	0.001	2	716	0.000	2	716	0.001
17:00 - 18:00	2	716	0.000	2	716	0.001	2	716	0.001
18:00 - 19:00	2	716	0.001	2	716	0.000	2	716	0.001
19:00 - 20:00									
20:00 - 21:00									
21:00 - 22:00									
22:00 - 23:00									
23:00 - 24:00									
Total Rates:			0.004			0.006			0.010

This section displays the trip rate results based on the selected set of surveys and the selected count type (shown just above the table). It is split by three main columns, representing arrivals trips, departures trips, and total trips (arrivals plus departures). Within each of these main columns are three sub-columns. These display the number of survey days where count data is included (per time period), the average value of the selected trip rate calculation parameter (per time period), and the trip rate result (per time period). Total trip rates (the sum of the column) are also displayed at the foot of the table.

To obtain a trip rate, the average (mean) trip rate parameter value (TRP) is first calculated for all selected survey days that have count data available for the stated time period. The average (mean) number of arrivals, departures or totals (whichever applies) is also calculated (COUNT) for all selected survey days that have count data available for the stated time period. Then, the average count is divided by the average trip rate parameter value, and multiplied by the stated calculation factor (shown just above the table and abbreviated here as FACT). So, the method is: COUNT/TRP*FACT. Trip rates are then rounded to 3 decimal places.

WYG Executive Park, Avalon Way Leicester

Licence No: 705102

TRIP RATE for Land Use 03 - RESIDENTIAL/A - HOUSES PRIVATELY OWNED

MULTI-MODAL COACH PASSENGERS

Calculation factor: **1 DWELLS**

BOLD print indicates peak (busiest) period

Time Range	ARRIVALS			DEPARTURES			TOTALS		
	No. Days	Ave. DWELLS	Trip Rate	No. Days	Ave. DWELLS	Trip Rate	No. Days	Ave. DWELLS	Trip Rate
00:00 - 01:00									
01:00 - 02:00									
02:00 - 03:00									
03:00 - 04:00									
04:00 - 05:00									
05:00 - 06:00									
06:00 - 07:00									
07:00 - 08:00	2	716	0.000	2	716	0.000	2	716	0.000
08:00 - 09:00	2	716	0.000	2	716	0.002	2	716	0.002
09:00 - 10:00	2	716	0.000	2	716	0.001	2	716	0.001
10:00 - 11:00	2	716	0.000	2	716	0.000	2	716	0.000
11:00 - 12:00	2	716	0.000	2	716	0.000	2	716	0.000
12:00 - 13:00	2	716	0.000	2	716	0.000	2	716	0.000
13:00 - 14:00	2	716	0.000	2	716	0.000	2	716	0.000
14:00 - 15:00	2	716	0.000	2	716	0.000	2	716	0.000
15:00 - 16:00	2	716	0.001	2	716	0.000	2	716	0.001
16:00 - 17:00	2	716	0.001	2	716	0.000	2	716	0.001
17:00 - 18:00	2	716	0.000	2	716	0.000	2	716	0.000
18:00 - 19:00	2	716	0.000	2	716	0.000	2	716	0.000
19:00 - 20:00									
20:00 - 21:00									
21:00 - 22:00									
22:00 - 23:00									
23:00 - 24:00									
Total Rates:			0.002			0.003			0.005

This section displays the trip rate results based on the selected set of surveys and the selected count type (shown just above the table). It is split by three main columns, representing arrivals trips, departures trips, and total trips (arrivals plus departures). Within each of these main columns are three sub-columns. These display the number of survey days where count data is included (per time period), the average value of the selected trip rate calculation parameter (per time period), and the trip rate result (per time period). Total trip rates (the sum of the column) are also displayed at the foot of the table.

To obtain a trip rate, the average (mean) trip rate parameter value (TRP) is first calculated for all selected survey days that have count data available for the stated time period. The average (mean) number of arrivals, departures or totals (whichever applies) is also calculated (COUNT) for all selected survey days that have count data available for the stated time period. Then, the average count is divided by the average trip rate parameter value, and multiplied by the stated calculation factor (shown just above the table and abbreviated here as FACT). So, the method is: COUNT/TRP*FACT. Trip rates are then rounded to 3 decimal places.

WYG Executive Park, Avalon Way Leicester

Licence No: 705102

TRIP RATE for Land Use 03 - RESIDENTIAL/A - HOUSES PRIVATELY OWNED

MULTI-MODAL PUBLIC TRANSPORT USERS

Calculation factor: 1 DWELLS

BOLD print indicates peak (busiest) period

Time Range	ARRIVALS			DEPARTURES			TOTALS		
	No. Days	Ave. DWELLS	Trip Rate	No. Days	Ave. DWELLS	Trip Rate	No. Days	Ave. DWELLS	Trip Rate
00:00 - 01:00									
01:00 - 02:00									
02:00 - 03:00									
03:00 - 04:00									
04:00 - 05:00									
05:00 - 06:00									
06:00 - 07:00									
07:00 - 08:00	2	716	0.003	2	716	0.029	2	716	0.032
08:00 - 09:00	2	716	0.000	2	716	0.008	2	716	0.008
09:00 - 10:00	2	716	0.001	2	716	0.006	2	716	0.007
10:00 - 11:00	2	716	0.001	2	716	0.003	2	716	0.004
11:00 - 12:00	2	716	0.002	2	716	0.006	2	716	0.008
12:00 - 13:00	2	716	0.002	2	716	0.003	2	716	0.005
13:00 - 14:00	2	716	0.003	2	716	0.001	2	716	0.004
14:00 - 15:00	2	716	0.006	2	716	0.003	2	716	0.009
15:00 - 16:00	2	716	0.013	2	716	0.003	2	716	0.016
16:00 - 17:00	2	716	0.010	2	716	0.000	2	716	0.010
17:00 - 18:00	2	716	0.006	2	716	0.001	2	716	0.007
18:00 - 19:00	2	716	0.009	2	716	0.000	2	716	0.009
19:00 - 20:00									
20:00 - 21:00									
21:00 - 22:00									
22:00 - 23:00									
23:00 - 24:00									
Total Rates:			0.056			0.063			0.119

This section displays the trip rate results based on the selected set of surveys and the selected count type (shown just above the table). It is split by three main columns, representing arrivals trips, departures trips, and total trips (arrivals plus departures). Within each of these main columns are three sub-columns. These display the number of survey days where count data is included (per time period), the average value of the selected trip rate calculation parameter (per time period), and the trip rate result (per time period). Total trip rates (the sum of the column) are also displayed at the foot of the table.

To obtain a trip rate, the average (mean) trip rate parameter value (TRP) is first calculated for all selected survey days that have count data available for the stated time period. The average (mean) number of arrivals, departures or totals (whichever applies) is also calculated (COUNT) for all selected survey days that have count data available for the stated time period. Then, the average count is divided by the average trip rate parameter value, and multiplied by the stated calculation factor (shown just above the table and abbreviated here as FACT). So, the method is: COUNT/TRP*FACT. Trip rates are then rounded to 3 decimal places.

WYG Executive Park, Avalon Way Leicester

Licence No: 705102

TRIP RATE for Land Use 03 - RESIDENTIAL/A - HOUSES PRIVATELY OWNED

MULTI-MODAL TOTAL PEOPLE

Calculation factor: 1 DWELLS

BOLD print indicates peak (busiest) period

Total People to Total Vehicles ratio (all time periods and directions): 1.57

Time Range	ARRIVALS			DEPARTURES			TOTALS		
	No. Days	Ave. DWELLS	Trip Rate	No. Days	Ave. DWELLS	Trip Rate	No. Days	Ave. DWELLS	Trip Rate
00:00 - 01:00									
01:00 - 02:00									
02:00 - 03:00									
03:00 - 04:00									
04:00 - 05:00									
05:00 - 06:00									
06:00 - 07:00									
07:00 - 08:00	2	716	0.101	2	716	0.497	2	716	0.598
08:00 - 09:00	2	716	0.221	2	716	0.888	2	716	1.109
09:00 - 10:00	2	716	0.187	2	716	0.198	2	716	0.385
10:00 - 11:00	2	716	0.161	2	716	0.185	2	716	0.346
11:00 - 12:00	2	716	0.161	2	716	0.185	2	716	0.346
12:00 - 13:00	2	716	0.178	2	716	0.166	2	716	0.344
13:00 - 14:00	2	716	0.193	2	716	0.195	2	716	0.388
14:00 - 15:00	2	716	0.207	2	716	0.239	2	716	0.446
15:00 - 16:00	2	716	0.594	2	716	0.242	2	716	0.836
16:00 - 17:00	2	716	0.487	2	716	0.239	2	716	0.726
17:00 - 18:00	2	716	0.618	2	716	0.309	2	716	0.927
18:00 - 19:00	2	716	0.524	2	716	0.318	2	716	0.842
19:00 - 20:00									
20:00 - 21:00									
21:00 - 22:00									
22:00 - 23:00									
23:00 - 24:00									
Total Rates:			3.632			3.661			7.293

This section displays the trip rate results based on the selected set of surveys and the selected count type (shown just above the table). It is split by three main columns, representing arrivals trips, departures trips, and total trips (arrivals plus departures). Within each of these main columns are three sub-columns. These display the number of survey days where count data is included (per time period), the average value of the selected trip rate calculation parameter (per time period), and the trip rate result (per time period). Total trip rates (the sum of the column) are also displayed at the foot of the table.

To obtain a trip rate, the average (mean) trip rate parameter value (TRP) is first calculated for all selected survey days that have count data available for the stated time period. The average (mean) number of arrivals, departures or totals (whichever applies) is also calculated (COUNT) for all selected survey days that have count data available for the stated time period. Then, the average count is divided by the average trip rate parameter value, and multiplied by the stated calculation factor (shown just above the table and abbreviated here as FACT). So, the method is: COUNT/TRP*FACT. Trip rates are then rounded to 3 decimal places.

WYG Executive Park, Avalon Way Leicester

Licence No: 705102

TRIP RATE for Land Use 03 - RESIDENTIAL/A - HOUSES PRIVATELY OWNED

MULTI-MODAL CARS

Calculation factor: 1 DWELLS

BOLD print indicates peak (busiest) period

Time Range	ARRIVALS			DEPARTURES			TOTALS		
	No. Days	Ave. DWELLS	Trip Rate	No. Days	Ave. DWELLS	Trip Rate	No. Days	Ave. DWELLS	Trip Rate
00:00 - 01:00									
01:00 - 02:00									
02:00 - 03:00									
03:00 - 04:00									
04:00 - 05:00									
05:00 - 06:00									
06:00 - 07:00									
07:00 - 08:00	2	716	0.056	2	716	0.297	2	716	0.353
08:00 - 09:00	2	716	0.138	2	716	0.409	2	716	0.547
09:00 - 10:00	2	716	0.124	2	716	0.135	2	716	0.259
10:00 - 11:00	2	716	0.089	2	716	0.108	2	716	0.197
11:00 - 12:00	2	716	0.095	2	716	0.113	2	716	0.208
12:00 - 13:00	2	716	0.115	2	716	0.110	2	716	0.225
13:00 - 14:00	2	716	0.128	2	716	0.127	2	716	0.255
14:00 - 15:00	2	716	0.117	2	716	0.165	2	716	0.282
15:00 - 16:00	2	716	0.242	2	716	0.152	2	716	0.394
16:00 - 17:00	2	716	0.267	2	716	0.141	2	716	0.408
17:00 - 18:00	2	716	0.383	2	716	0.164	2	716	0.547
18:00 - 19:00	2	716	0.309	2	716	0.170	2	716	0.479
19:00 - 20:00									
20:00 - 21:00									
21:00 - 22:00									
22:00 - 23:00									
23:00 - 24:00									
Total Rates:			2.063			2.091			4.154

This section displays the trip rate results based on the selected set of surveys and the selected count type (shown just above the table). It is split by three main columns, representing arrivals trips, departures trips, and total trips (arrivals plus departures). Within each of these main columns are three sub-columns. These display the number of survey days where count data is included (per time period), the average value of the selected trip rate calculation parameter (per time period), and the trip rate result (per time period). Total trip rates (the sum of the column) are also displayed at the foot of the table.

To obtain a trip rate, the average (mean) trip rate parameter value (TRP) is first calculated for all selected survey days that have count data available for the stated time period. The average (mean) number of arrivals, departures or totals (whichever applies) is also calculated (COUNT) for all selected survey days that have count data available for the stated time period. Then, the average count is divided by the average trip rate parameter value, and multiplied by the stated calculation factor (shown just above the table and abbreviated here as FACT). So, the method is: COUNT/TRP*FACT. Trip rates are then rounded to 3 decimal places.

WYG Executive Park, Avalon Way Leicester

Licence No: 705102

TRIP RATE for Land Use 03 - RESIDENTIAL/A - HOUSES PRIVATELY OWNED

MULTI-MODAL LGVS

Calculation factor: 1 DWELLS

BOLD print indicates peak (busiest) period

Time Range	ARRIVALS			DEPARTURES			TOTALS		
	No. Days	Ave. DWELLS	Trip Rate	No. Days	Ave. DWELLS	Trip Rate	No. Days	Ave. DWELLS	Trip Rate
00:00 - 01:00									
01:00 - 02:00									
02:00 - 03:00									
03:00 - 04:00									
04:00 - 05:00									
05:00 - 06:00									
06:00 - 07:00									
07:00 - 08:00	2	716	0.009	2	716	0.027	2	716	0.036
08:00 - 09:00	2	716	0.013	2	716	0.018	2	716	0.031
09:00 - 10:00	2	716	0.016	2	716	0.014	2	716	0.030
10:00 - 11:00	2	716	0.018	2	716	0.019	2	716	0.037
11:00 - 12:00	2	716	0.020	2	716	0.019	2	716	0.039
12:00 - 13:00	2	716	0.016	2	716	0.015	2	716	0.031
13:00 - 14:00	2	716	0.014	2	716	0.018	2	716	0.032
14:00 - 15:00	2	716	0.019	2	716	0.017	2	716	0.036
15:00 - 16:00	2	716	0.017	2	716	0.017	2	716	0.034
16:00 - 17:00	2	716	0.031	2	716	0.017	2	716	0.048
17:00 - 18:00	2	716	0.022	2	716	0.014	2	716	0.036
18:00 - 19:00	2	716	0.014	2	716	0.007	2	716	0.021
19:00 - 20:00									
20:00 - 21:00									
21:00 - 22:00									
22:00 - 23:00									
23:00 - 24:00									
Total Rates:			0.209			0.202			0.411

This section displays the trip rate results based on the selected set of surveys and the selected count type (shown just above the table). It is split by three main columns, representing arrivals trips, departures trips, and total trips (arrivals plus departures). Within each of these main columns are three sub-columns. These display the number of survey days where count data is included (per time period), the average value of the selected trip rate calculation parameter (per time period), and the trip rate result (per time period). Total trip rates (the sum of the column) are also displayed at the foot of the table.

To obtain a trip rate, the average (mean) trip rate parameter value (TRP) is first calculated for all selected survey days that have count data available for the stated time period. The average (mean) number of arrivals, departures or totals (whichever applies) is also calculated (COUNT) for all selected survey days that have count data available for the stated time period. Then, the average count is divided by the average trip rate parameter value, and multiplied by the stated calculation factor (shown just above the table and abbreviated here as FACT). So, the method is: COUNT/TRP*FACT. Trip rates are then rounded to 3 decimal places.

WYG Executive Park, Avalon Way Leicester

Licence No: 705102

TRIP RATE for Land Use 03 - RESIDENTIAL/A - HOUSES PRIVATELY OWNED

MULTI-MODAL MOTOR CYCLES

Calculation factor: 1 DWELLS

BOLD print indicates peak (busiest) period

Time Range	ARRIVALS			DEPARTURES			TOTALS		
	No. Days	Ave. DWELLS	Trip Rate	No. Days	Ave. DWELLS	Trip Rate	No. Days	Ave. DWELLS	Trip Rate
00:00 - 01:00									
01:00 - 02:00									
02:00 - 03:00									
03:00 - 04:00									
04:00 - 05:00									
05:00 - 06:00									
06:00 - 07:00									
07:00 - 08:00	2	716	0.001	2	716	0.002	2	716	0.003
08:00 - 09:00	2	716	0.001	2	716	0.005	2	716	0.006
09:00 - 10:00	2	716	0.000	2	716	0.000	2	716	0.000
10:00 - 11:00	2	716	0.001	2	716	0.001	2	716	0.002
11:00 - 12:00	2	716	0.000	2	716	0.001	2	716	0.001
12:00 - 13:00	2	716	0.000	2	716	0.001	2	716	0.001
13:00 - 14:00	2	716	0.000	2	716	0.000	2	716	0.000
14:00 - 15:00	2	716	0.000	2	716	0.000	2	716	0.000
15:00 - 16:00	2	716	0.000	2	716	0.000	2	716	0.000
16:00 - 17:00	2	716	0.001	2	716	0.001	2	716	0.002
17:00 - 18:00	2	716	0.001	2	716	0.000	2	716	0.001
18:00 - 19:00	2	716	0.006	2	716	0.002	2	716	0.008
19:00 - 20:00									
20:00 - 21:00									
21:00 - 22:00									
22:00 - 23:00									
23:00 - 24:00									
Total Rates:			0.011			0.013			0.024

This section displays the trip rate results based on the selected set of surveys and the selected count type (shown just above the table). It is split by three main columns, representing arrivals trips, departures trips, and total trips (arrivals plus departures). Within each of these main columns are three sub-columns. These display the number of survey days where count data is included (per time period), the average value of the selected trip rate calculation parameter (per time period), and the trip rate result (per time period). Total trip rates (the sum of the column) are also displayed at the foot of the table.

To obtain a trip rate, the average (mean) trip rate parameter value (TRP) is first calculated for all selected survey days that have count data available for the stated time period. The average (mean) number of arrivals, departures or totals (whichever applies) is also calculated (COUNT) for all selected survey days that have count data available for the stated time period. Then, the average count is divided by the average trip rate parameter value, and multiplied by the stated calculation factor (shown just above the table and abbreviated here as FACT). So, the method is: COUNT/TRP*FACT. Trip rates are then rounded to 3 decimal places.

WYG Executive Park, Avalon Way Leicester

Licence No: 705102

Calculation Reference: AUDIT-705102-220518-0550

TRIP RATE CALCULATION SELECTION PARAMETERS:

Land Use : 03 - RESIDENTIAL
 Category : A - HOUSES PRIVATELY OWNED

MULTI-MODAL TOTAL VEHICLESSelected regions and areas:

02	SOUTH EAST	
	KC KENT	1 days
	SC SURREY	1 days
03	SOUTH WEST	
	DC DORSET	1 days
	DV DEVON	1 days
	SM SOMERSET	1 days
	WL WILTSHIRE	1 days

This section displays the number of survey days per TRICS® sub-region in the selected set

Primary Filtering selection:

This data displays the chosen trip rate parameter and its selected range. Only sites that fall within the parameter range are included in the trip rate calculation.

Parameter: No of Dwellings
 Actual Range: 27 to 116 (units:)
 Range Selected by User: 4 to 130 (units:)

Parking Spaces Range: All Surveys Included

Parking Spaces per Dwelling Range: All Surveys Included

Bedrooms per Dwelling Range: All Surveys Included

Percentage of dwellings privately owned: All Surveys Included

Public Transport Provision:

Selection by: Include all surveys

Date Range: 01/01/14 to 24/11/21

This data displays the range of survey dates selected. Only surveys that were conducted within this date range are included in the trip rate calculation.

Selected survey days:

Monday	1 days
Thursday	4 days
Friday	1 days

This data displays the number of selected surveys by day of the week.

Selected survey types:

Manual count	6 days
Directional ATC Count	0 days

This data displays the number of manual classified surveys and the number of unclassified ATC surveys, the total adding up to the overall number of surveys in the selected set. Manual surveys are undertaken using staff, whilst ATC surveys are undertaken using machines.

Selected Locations:

Suburban Area (PPS6 Out of Centre)	3
Edge of Town	3

This data displays the number of surveys per main location category within the selected set. The main location categories consist of Free Standing, Edge of Town, Suburban Area, Neighbourhood Centre, Edge of Town Centre, Town Centre and Not Known.

Selected Location Sub Categories:

Residential Zone	6
------------------	---

This data displays the number of surveys per location sub-category within the selected set. The location sub-categories consist of Commercial Zone, Industrial Zone, Development Zone, Residential Zone, Retail Zone, Built-Up Zone, Village, Out of Town, High Street and No Sub Category.

Secondary Filtering selection:Use Class:

C3 6 days

This data displays the number of surveys per Use Class classification within the selected set. The Use Classes Order 2005 has been used for this purpose, which can be found within the Library module of TRICS®.

Population within 500m Range:

All Surveys Included

Population within 1 mile:

5,001 to 10,000	1 days
10,001 to 15,000	1 days
15,001 to 20,000	1 days
20,001 to 25,000	1 days
25,001 to 50,000	2 days

This data displays the number of selected surveys within stated 1-mile radii of population.

Population within 5 miles:

5,001 to 25,000	1 days
50,001 to 75,000	1 days
75,001 to 100,000	1 days
100,001 to 125,000	1 days
125,001 to 250,000	1 days
250,001 to 500,000	1 days

This data displays the number of selected surveys within stated 5-mile radii of population.

Car ownership within 5 miles:

1.1 to 1.5 6 days

This data displays the number of selected surveys within stated ranges of average cars owned per residential dwelling, within a radius of 5-miles of selected survey sites.

Travel Plan:

No 6 days

This data displays the number of surveys within the selected set that were undertaken at sites with Travel Plans in place, and the number of surveys that were undertaken at sites without Travel Plans.

PTAL Rating:

No PTAL Present 6 days

This data displays the number of selected surveys with PTAL Ratings.

LIST OF SITES relevant to selection parameters

- | | | | |
|----------|---|---------------------------------|---------------------|
| 1 | DC-03-A-08 | BUNGALOWS | DORSET |
| | HURSTDENE ROAD
BOURNEMOUTH
CASTLE LANE WEST
Edge of Town
Residential Zone
Total No of Dwellings: 28
Survey date: MONDAY 24/03/14 | | Survey Type: MANUAL |
| 2 | DV-03-A-02 | HOUSES & BUNGALOWS | DEVON |
| | MILLHEAD ROAD
HONITON

Suburban Area (PPS6 Out of Centre)
Residential Zone
Total No of Dwellings: 116
Survey date: FRIDAY 25/09/15 | | Survey Type: MANUAL |
| 3 | KC-03-A-03 | MIXED HOUSES & FLATS | KENT |
| | HYTHE ROAD
ASHFORD
WILLESBOROUGH
Suburban Area (PPS6 Out of Centre)
Residential Zone
Total No of Dwellings: 51
Survey date: THURSDAY 14/07/16 | | Survey Type: MANUAL |
| 4 | SC-03-A-04 | DETACHED & TERRACED | SURREY |
| | HIGH ROAD
BYFLEET

Edge of Town
Residential Zone
Total No of Dwellings: 71
Survey date: THURSDAY 23/01/14 | | Survey Type: MANUAL |
| 5 | SM-03-A-01 | DETACHED & SEMI | SOMERSET |
| | WEMBDON ROAD
BRIDGWATER
NORTHFIELD
Edge of Town
Residential Zone
Total No of Dwellings: 33
Survey date: THURSDAY 24/09/15 | | Survey Type: MANUAL |
| 6 | WL-03-A-02 | SEMI DETACHED | WILTSHIRE |
| | HEADLANDS GROVE
SWINDON

Suburban Area (PPS6 Out of Centre)
Residential Zone
Total No of Dwellings: 27
Survey date: THURSDAY 22/09/16 | | Survey Type: MANUAL |

This section provides a list of all survey sites and days in the selected set. For each individual survey site, it displays a unique site reference code and site address, the selected trip rate calculation parameter and its value, the day of the week and date of each survey, and whether the survey was a manual classified count or an ATC count.

MANUALLY DESELECTED SITES

Site Ref	Reason for Deselection
CA-03-A-05	Census Data Comparison
CH-03-A-09	Census Data Comparison
CH-03-A-10	Census Data Comparison
CH-03-A-11	Census Data Comparison
CV-03-A-02	Census Data Comparison
CV-03-A-03	Census Data Comparison
DC-03-A-09	Census Data Comparison
DH-03-A-01	Census Data Comparison
DH-03-A-03	Census Data Comparison
DL-03-A-10	Census Data Comparison
DL-03-A-11	Census Data Comparison
DN-03-A-03	Census Data Comparison
DN-03-A-04	Census Data Comparison
DN-03-A-06	Census Data Comparison
DV-03-A-01	Census Data Comparison

MANUALLY DESELECTED SITES (Cont.)

Site Ref	Reason for Deselection
DV-03-A-03	Census Data Comparison
EN-03-A-01	Census Data Comparison
ES-03-A-05	Census Data Comparison
EX-03-A-03	Census Data Comparison
HC-03-A-21	Census Data Comparison
HC-03-A-22	Census Data Comparison
HC-03-A-23	Census Data Comparison
HC-03-A-27	Census Data Comparison
HC-03-A-28	Census Data Comparison
HF-03-A-04	Census Data Comparison
HI-03-A-14	Census Data Comparison
KC-03-A-04	Census Data Comparison
KC-03-A-09	Census Data Comparison
LT-03-A-01	Census Data Comparison
MG-03-A-01	Census Data Comparison
NF-03-A-03	Census Data Comparison
NF-03-A-25	Census Data Comparison
NT-03-A-08	Census Data Comparison
NY-03-A-13	Census Data Comparison
PS-03-A-02	Census Data Comparison
RO-03-A-03	Census Data Comparison
RO-03-A-04	Census Data Comparison
SF-03-A-05	Census Data Comparison
SH-03-A-06	Census Data Comparison
TI-03-A-01	Census Data Comparison
TY-03-A-02	Census Data Comparison
VG-03-A-01	Census Data Comparison
WC-03-A-01	Census Data Comparison
WK-03-A-04	Census Data Comparison
WS-03-A-14	Census Data Comparison
WX-03-A-01	Census Data Comparison

WYG Executive Park, Avalon Way Leicester

Licence No: 705102

TRIP RATE for Land Use 03 - RESIDENTIAL/A - HOUSES PRIVATELY OWNED

MULTI-MODAL TOTAL VEHICLES

Calculation factor: 1 DWELLS

BOLD print indicates peak (busiest) period

Total People to Total Vehicles ratio (all time periods and directions): 1.60

Time Range	ARRIVALS			DEPARTURES			TOTALS		
	No. Days	Ave. DWELLS	Trip Rate	No. Days	Ave. DWELLS	Trip Rate	No. Days	Ave. DWELLS	Trip Rate
00:00 - 01:00									
01:00 - 02:00									
02:00 - 03:00									
03:00 - 04:00									
04:00 - 05:00									
05:00 - 06:00									
06:00 - 07:00									
07:00 - 08:00	6	54	0.077	6	54	0.267	6	54	0.344
08:00 - 09:00	6	54	0.163	6	54	0.340	6	54	0.503
09:00 - 10:00	6	54	0.172	6	54	0.209	6	54	0.381
10:00 - 11:00	6	54	0.209	6	54	0.255	6	54	0.464
11:00 - 12:00	6	54	0.212	6	54	0.221	6	54	0.433
12:00 - 13:00	6	54	0.242	6	54	0.245	6	54	0.487
13:00 - 14:00	6	54	0.218	6	54	0.227	6	54	0.445
14:00 - 15:00	6	54	0.206	6	54	0.209	6	54	0.415
15:00 - 16:00	6	54	0.301	6	54	0.199	6	54	0.500
16:00 - 17:00	6	54	0.288	6	54	0.206	6	54	0.494
17:00 - 18:00	6	54	0.393	6	54	0.206	6	54	0.599
18:00 - 19:00	6	54	0.224	6	54	0.160	6	54	0.384
19:00 - 20:00									
20:00 - 21:00									
21:00 - 22:00									
22:00 - 23:00									
23:00 - 24:00									
Total Rates:			2.705			2.744			5.449

This section displays the trip rate results based on the selected set of surveys and the selected count type (shown just above the table). It is split by three main columns, representing arrivals trips, departures trips, and total trips (arrivals plus departures). Within each of these main columns are three sub-columns. These display the number of survey days where count data is included (per time period), the average value of the selected trip rate calculation parameter (per time period), and the trip rate result (per time period). Total trip rates (the sum of the column) are also displayed at the foot of the table.

To obtain a trip rate, the average (mean) trip rate parameter value (TRP) is first calculated for all selected survey days that have count data available for the stated time period. The average (mean) number of arrivals, departures or totals (whichever applies) is also calculated (COUNT) for all selected survey days that have count data available for the stated time period. Then, the average count is divided by the average trip rate parameter value, and multiplied by the stated calculation factor (shown just above the table and abbreviated here as FACT). So, the method is: COUNT/TRP*FACT. Trip rates are then rounded to 3 decimal places.

The survey data, graphs and all associated supporting information, contained within the TRICS Database are published by TRICS Consortium Limited ("the Company") and the Company claims copyright and database rights in this published work. The Company authorises those who possess a current TRICS licence to access the TRICS Database and copy the data contained within the TRICS Database for the licence holders' use only. Any resulting copy must retain all copyrights and other proprietary notices, and any disclaimer contained thereon.

The Company accepts no responsibility for loss which may arise from reliance on data contained in the TRICS Database. [No warranty of any kind, express or implied, is made as to the data contained in the TRICS Database.]

Parameter summary

Trip rate parameter range selected: 27 - 116 (units:)
 Survey date range: 01/01/14 - 24/11/21
 Number of weekdays (Monday-Friday): 6
 Number of Saturdays: 0
 Number of Sundays: 0
 Surveys automatically removed from selection: 8
 Surveys manually removed from selection: 46

This section displays a quick summary of some of the data filtering selections made by the TRICS® user. The trip rate calculation parameter range of all selected surveys is displayed first, followed by the range of minimum and maximum survey dates selected by the user. Then, the total number of selected weekdays and weekend days in the selected set of surveys are shown. Finally, the number of survey days that have been manually removed from the selected set outside of the standard filtering procedure are displayed.

WYG Executive Park, Avalon Way Leicester

Licence No: 705102

TRIP RATE for Land Use 03 - RESIDENTIAL/A - HOUSES PRIVATELY OWNED

MULTI-MODAL TAXIS

Calculation factor: 1 DWELLS

BOLD print indicates peak (busiest) period

Time Range	ARRIVALS			DEPARTURES			TOTALS		
	No. Days	Ave. DWELLS	Trip Rate	No. Days	Ave. DWELLS	Trip Rate	No. Days	Ave. DWELLS	Trip Rate
00:00 - 01:00									
01:00 - 02:00									
02:00 - 03:00									
03:00 - 04:00									
04:00 - 05:00									
05:00 - 06:00									
06:00 - 07:00									
07:00 - 08:00	6	54	0.000	6	54	0.000	6	54	0.000
08:00 - 09:00	6	54	0.000	6	54	0.000	6	54	0.000
09:00 - 10:00	6	54	0.003	6	54	0.003	6	54	0.006
10:00 - 11:00	6	54	0.003	6	54	0.003	6	54	0.006
11:00 - 12:00	6	54	0.000	6	54	0.000	6	54	0.000
12:00 - 13:00	6	54	0.000	6	54	0.000	6	54	0.000
13:00 - 14:00	6	54	0.000	6	54	0.000	6	54	0.000
14:00 - 15:00	6	54	0.000	6	54	0.000	6	54	0.000
15:00 - 16:00	6	54	0.000	6	54	0.000	6	54	0.000
16:00 - 17:00	6	54	0.000	6	54	0.000	6	54	0.000
17:00 - 18:00	6	54	0.000	6	54	0.000	6	54	0.000
18:00 - 19:00	6	54	0.003	6	54	0.003	6	54	0.006
19:00 - 20:00									
20:00 - 21:00									
21:00 - 22:00									
22:00 - 23:00									
23:00 - 24:00									
Total Rates:			0.009			0.009			0.018

This section displays the trip rate results based on the selected set of surveys and the selected count type (shown just above the table). It is split by three main columns, representing arrivals trips, departures trips, and total trips (arrivals plus departures). Within each of these main columns are three sub-columns. These display the number of survey days where count data is included (per time period), the average value of the selected trip rate calculation parameter (per time period), and the trip rate result (per time period). Total trip rates (the sum of the column) are also displayed at the foot of the table.

To obtain a trip rate, the average (mean) trip rate parameter value (TRP) is first calculated for all selected survey days that have count data available for the stated time period. The average (mean) number of arrivals, departures or totals (whichever applies) is also calculated (COUNT) for all selected survey days that have count data available for the stated time period. Then, the average count is divided by the average trip rate parameter value, and multiplied by the stated calculation factor (shown just above the table and abbreviated here as FACT). So, the method is: COUNT/TRP*FACT. Trip rates are then rounded to 3 decimal places.

WYG Executive Park, Avalon Way Leicester

Licence No: 705102

TRIP RATE for Land Use 03 - RESIDENTIAL/A - HOUSES PRIVATELY OWNED

MULTI-MODAL OGVS

Calculation factor: 1 DWELLS

BOLD print indicates peak (busiest) period

Time Range	ARRIVALS			DEPARTURES			TOTALS		
	No. Days	Ave. DWELLS	Trip Rate	No. Days	Ave. DWELLS	Trip Rate	No. Days	Ave. DWELLS	Trip Rate
00:00 - 01:00									
01:00 - 02:00									
02:00 - 03:00									
03:00 - 04:00									
04:00 - 05:00									
05:00 - 06:00									
06:00 - 07:00									
07:00 - 08:00	6	54	0.000	6	54	0.000	6	54	0.000
08:00 - 09:00	6	54	0.000	6	54	0.000	6	54	0.000
09:00 - 10:00	6	54	0.000	6	54	0.000	6	54	0.000
10:00 - 11:00	6	54	0.000	6	54	0.000	6	54	0.000
11:00 - 12:00	6	54	0.000	6	54	0.000	6	54	0.000
12:00 - 13:00	6	54	0.000	6	54	0.000	6	54	0.000
13:00 - 14:00	6	54	0.003	6	54	0.000	6	54	0.003
14:00 - 15:00	6	54	0.003	6	54	0.006	6	54	0.009
15:00 - 16:00	6	54	0.003	6	54	0.003	6	54	0.006
16:00 - 17:00	6	54	0.000	6	54	0.000	6	54	0.000
17:00 - 18:00	6	54	0.000	6	54	0.000	6	54	0.000
18:00 - 19:00	6	54	0.000	6	54	0.000	6	54	0.000
19:00 - 20:00									
20:00 - 21:00									
21:00 - 22:00									
22:00 - 23:00									
23:00 - 24:00									
Total Rates:			0.009			0.009			0.018

This section displays the trip rate results based on the selected set of surveys and the selected count type (shown just above the table). It is split by three main columns, representing arrivals trips, departures trips, and total trips (arrivals plus departures). Within each of these main columns are three sub-columns. These display the number of survey days where count data is included (per time period), the average value of the selected trip rate calculation parameter (per time period), and the trip rate result (per time period). Total trip rates (the sum of the column) are also displayed at the foot of the table.

To obtain a trip rate, the average (mean) trip rate parameter value (TRP) is first calculated for all selected survey days that have count data available for the stated time period. The average (mean) number of arrivals, departures or totals (whichever applies) is also calculated (COUNT) for all selected survey days that have count data available for the stated time period. Then, the average count is divided by the average trip rate parameter value, and multiplied by the stated calculation factor (shown just above the table and abbreviated here as FACT). So, the method is: COUNT/TRP*FACT. Trip rates are then rounded to 3 decimal places.

WYG Executive Park, Avalon Way Leicester

Licence No: 705102

TRIP RATE for Land Use 03 - RESIDENTIAL/A - HOUSES PRIVATELY OWNED

MULTI-MODAL PSVS

Calculation factor: 1 DWELLS

BOLD print indicates peak (busiest) period

Time Range	ARRIVALS			DEPARTURES			TOTALS		
	No. Days	Ave. DWELLS	Trip Rate	No. Days	Ave. DWELLS	Trip Rate	No. Days	Ave. DWELLS	Trip Rate
00:00 - 01:00									
01:00 - 02:00									
02:00 - 03:00									
03:00 - 04:00									
04:00 - 05:00									
05:00 - 06:00									
06:00 - 07:00									
07:00 - 08:00	6	54	0.000	6	54	0.000	6	54	0.000
08:00 - 09:00	6	54	0.006	6	54	0.006	6	54	0.012
09:00 - 10:00	6	54	0.000	6	54	0.000	6	54	0.000
10:00 - 11:00	6	54	0.000	6	54	0.000	6	54	0.000
11:00 - 12:00	6	54	0.000	6	54	0.000	6	54	0.000
12:00 - 13:00	6	54	0.000	6	54	0.000	6	54	0.000
13:00 - 14:00	6	54	0.000	6	54	0.000	6	54	0.000
14:00 - 15:00	6	54	0.000	6	54	0.000	6	54	0.000
15:00 - 16:00	6	54	0.006	6	54	0.006	6	54	0.012
16:00 - 17:00	6	54	0.000	6	54	0.000	6	54	0.000
17:00 - 18:00	6	54	0.000	6	54	0.000	6	54	0.000
18:00 - 19:00	6	54	0.000	6	54	0.000	6	54	0.000
19:00 - 20:00									
20:00 - 21:00									
21:00 - 22:00									
22:00 - 23:00									
23:00 - 24:00									
Total Rates:			0.012			0.012			0.024

This section displays the trip rate results based on the selected set of surveys and the selected count type (shown just above the table). It is split by three main columns, representing arrivals trips, departures trips, and total trips (arrivals plus departures). Within each of these main columns are three sub-columns. These display the number of survey days where count data is included (per time period), the average value of the selected trip rate calculation parameter (per time period), and the trip rate result (per time period). Total trip rates (the sum of the column) are also displayed at the foot of the table.

To obtain a trip rate, the average (mean) trip rate parameter value (TRP) is first calculated for all selected survey days that have count data available for the stated time period. The average (mean) number of arrivals, departures or totals (whichever applies) is also calculated (COUNT) for all selected survey days that have count data available for the stated time period. Then, the average count is divided by the average trip rate parameter value, and multiplied by the stated calculation factor (shown just above the table and abbreviated here as FACT). So, the method is: COUNT/TRP*FACT. Trip rates are then rounded to 3 decimal places.

WYG Executive Park, Avalon Way Leicester

Licence No: 705102

TRIP RATE for Land Use 03 - RESIDENTIAL/A - HOUSES PRIVATELY OWNED

MULTI-MODAL CYCLISTS

Calculation factor: 1 DWELLS

BOLD print indicates peak (busiest) period

Time Range	ARRIVALS			DEPARTURES			TOTALS		
	No. Days	Ave. DWELLS	Trip Rate	No. Days	Ave. DWELLS	Trip Rate	No. Days	Ave. DWELLS	Trip Rate
00:00 - 01:00									
01:00 - 02:00									
02:00 - 03:00									
03:00 - 04:00									
04:00 - 05:00									
05:00 - 06:00									
06:00 - 07:00									
07:00 - 08:00	6	54	0.018	6	54	0.021	6	54	0.039
08:00 - 09:00	6	54	0.000	6	54	0.012	6	54	0.012
09:00 - 10:00	6	54	0.000	6	54	0.000	6	54	0.000
10:00 - 11:00	6	54	0.000	6	54	0.006	6	54	0.006
11:00 - 12:00	6	54	0.003	6	54	0.003	6	54	0.006
12:00 - 13:00	6	54	0.003	6	54	0.003	6	54	0.006
13:00 - 14:00	6	54	0.003	6	54	0.000	6	54	0.003
14:00 - 15:00	6	54	0.006	6	54	0.006	6	54	0.012
15:00 - 16:00	6	54	0.012	6	54	0.000	6	54	0.012
16:00 - 17:00	6	54	0.006	6	54	0.003	6	54	0.009
17:00 - 18:00	6	54	0.009	6	54	0.006	6	54	0.015
18:00 - 19:00	6	54	0.006	6	54	0.000	6	54	0.006
19:00 - 20:00									
20:00 - 21:00									
21:00 - 22:00									
22:00 - 23:00									
23:00 - 24:00									
Total Rates:			0.066			0.060			0.126

This section displays the trip rate results based on the selected set of surveys and the selected count type (shown just above the table). It is split by three main columns, representing arrivals trips, departures trips, and total trips (arrivals plus departures). Within each of these main columns are three sub-columns. These display the number of survey days where count data is included (per time period), the average value of the selected trip rate calculation parameter (per time period), and the trip rate result (per time period). Total trip rates (the sum of the column) are also displayed at the foot of the table.

To obtain a trip rate, the average (mean) trip rate parameter value (TRP) is first calculated for all selected survey days that have count data available for the stated time period. The average (mean) number of arrivals, departures or totals (whichever applies) is also calculated (COUNT) for all selected survey days that have count data available for the stated time period. Then, the average count is divided by the average trip rate parameter value, and multiplied by the stated calculation factor (shown just above the table and abbreviated here as FACT). So, the method is: COUNT/TRP*FACT. Trip rates are then rounded to 3 decimal places.

WYG Executive Park, Avalon Way Leicester

Licence No: 705102

TRIP RATE for Land Use 03 - RESIDENTIAL/A - HOUSES PRIVATELY OWNED

MULTI-MODAL VEHICLE OCCUPANTS

Calculation factor: **1 DWELLS**

BOLD print indicates peak (busiest) period

Time Range	ARRIVALS			DEPARTURES			TOTALS		
	No. Days	Ave. DWELLS	Trip Rate	No. Days	Ave. DWELLS	Trip Rate	No. Days	Ave. DWELLS	Trip Rate
00:00 - 01:00									
01:00 - 02:00									
02:00 - 03:00									
03:00 - 04:00									
04:00 - 05:00									
05:00 - 06:00									
06:00 - 07:00									
07:00 - 08:00	6	54	0.086	6	54	0.313	6	54	0.399
08:00 - 09:00	6	54	0.175	6	54	0.500	6	54	0.675
09:00 - 10:00	6	54	0.187	6	54	0.261	6	54	0.448
10:00 - 11:00	6	54	0.236	6	54	0.337	6	54	0.573
11:00 - 12:00	6	54	0.245	6	54	0.279	6	54	0.524
12:00 - 13:00	6	54	0.288	6	54	0.301	6	54	0.589
13:00 - 14:00	6	54	0.279	6	54	0.279	6	54	0.558
14:00 - 15:00	6	54	0.255	6	54	0.236	6	54	0.491
15:00 - 16:00	6	54	0.454	6	54	0.261	6	54	0.715
16:00 - 17:00	6	54	0.405	6	54	0.328	6	54	0.733
17:00 - 18:00	6	54	0.552	6	54	0.310	6	54	0.862
18:00 - 19:00	6	54	0.322	6	54	0.224	6	54	0.546
19:00 - 20:00									
20:00 - 21:00									
21:00 - 22:00									
22:00 - 23:00									
23:00 - 24:00									
Total Rates:			3.484			3.629			7.113

This section displays the trip rate results based on the selected set of surveys and the selected count type (shown just above the table). It is split by three main columns, representing arrivals trips, departures trips, and total trips (arrivals plus departures). Within each of these main columns are three sub-columns. These display the number of survey days where count data is included (per time period), the average value of the selected trip rate calculation parameter (per time period), and the trip rate result (per time period). Total trip rates (the sum of the column) are also displayed at the foot of the table.

To obtain a trip rate, the average (mean) trip rate parameter value (TRP) is first calculated for all selected survey days that have count data available for the stated time period. The average (mean) number of arrivals, departures or totals (whichever applies) is also calculated (COUNT) for all selected survey days that have count data available for the stated time period. Then, the average count is divided by the average trip rate parameter value, and multiplied by the stated calculation factor (shown just above the table and abbreviated here as FACT). So, the method is: COUNT/TRP*FACT. Trip rates are then rounded to 3 decimal places.

WYG Executive Park, Avalon Way Leicester

Licence No: 705102

TRIP RATE for Land Use 03 - RESIDENTIAL/A - HOUSES PRIVATELY OWNED

MULTI-MODAL PEDESTRIANS

Calculation factor: 1 DWELLS

BOLD print indicates peak (busiest) period

Time Range	ARRIVALS			DEPARTURES			TOTALS		
	No. Days	Ave. DWELLS	Trip Rate	No. Days	Ave. DWELLS	Trip Rate	No. Days	Ave. DWELLS	Trip Rate
00:00 - 01:00									
01:00 - 02:00									
02:00 - 03:00									
03:00 - 04:00									
04:00 - 05:00									
05:00 - 06:00									
06:00 - 07:00									
07:00 - 08:00	6	54	0.012	6	54	0.021	6	54	0.033
08:00 - 09:00	6	54	0.052	6	54	0.172	6	54	0.224
09:00 - 10:00	6	54	0.064	6	54	0.061	6	54	0.125
10:00 - 11:00	6	54	0.064	6	54	0.071	6	54	0.135
11:00 - 12:00	6	54	0.043	6	54	0.058	6	54	0.101
12:00 - 13:00	6	54	0.037	6	54	0.046	6	54	0.083
13:00 - 14:00	6	54	0.040	6	54	0.046	6	54	0.086
14:00 - 15:00	6	54	0.031	6	54	0.055	6	54	0.086
15:00 - 16:00	6	54	0.123	6	54	0.049	6	54	0.172
16:00 - 17:00	6	54	0.092	6	54	0.046	6	54	0.138
17:00 - 18:00	6	54	0.049	6	54	0.049	6	54	0.098
18:00 - 19:00	6	54	0.031	6	54	0.018	6	54	0.049
19:00 - 20:00									
20:00 - 21:00									
21:00 - 22:00									
22:00 - 23:00									
23:00 - 24:00									
Total Rates:			0.638			0.692			1.330

This section displays the trip rate results based on the selected set of surveys and the selected count type (shown just above the table). It is split by three main columns, representing arrivals trips, departures trips, and total trips (arrivals plus departures). Within each of these main columns are three sub-columns. These display the number of survey days where count data is included (per time period), the average value of the selected trip rate calculation parameter (per time period), and the trip rate result (per time period). Total trip rates (the sum of the column) are also displayed at the foot of the table.

To obtain a trip rate, the average (mean) trip rate parameter value (TRP) is first calculated for all selected survey days that have count data available for the stated time period. The average (mean) number of arrivals, departures or totals (whichever applies) is also calculated (COUNT) for all selected survey days that have count data available for the stated time period. Then, the average count is divided by the average trip rate parameter value, and multiplied by the stated calculation factor (shown just above the table and abbreviated here as FACT). So, the method is: COUNT/TRP*FACT. Trip rates are then rounded to 3 decimal places.

WYG Executive Park, Avalon Way Leicester

Licence No: 705102

TRIP RATE for Land Use 03 - RESIDENTIAL/A - HOUSES PRIVATELY OWNED

MULTI-MODAL BUS/TRAM PASSENGERS

Calculation factor: 1 DWELLS

BOLD print indicates peak (busiest) period

Time Range	ARRIVALS			DEPARTURES			TOTALS		
	No. Days	Ave. DWELLS	Trip Rate	No. Days	Ave. DWELLS	Trip Rate	No. Days	Ave. DWELLS	Trip Rate
00:00 - 01:00									
01:00 - 02:00									
02:00 - 03:00									
03:00 - 04:00									
04:00 - 05:00									
05:00 - 06:00									
06:00 - 07:00									
07:00 - 08:00	6	54	0.003	6	54	0.015	6	54	0.018
08:00 - 09:00	6	54	0.003	6	54	0.003	6	54	0.006
09:00 - 10:00	6	54	0.003	6	54	0.003	6	54	0.006
10:00 - 11:00	6	54	0.006	6	54	0.012	6	54	0.018
11:00 - 12:00	6	54	0.006	6	54	0.003	6	54	0.009
12:00 - 13:00	6	54	0.000	6	54	0.003	6	54	0.003
13:00 - 14:00	6	54	0.000	6	54	0.000	6	54	0.000
14:00 - 15:00	6	54	0.003	6	54	0.003	6	54	0.006
15:00 - 16:00	6	54	0.006	6	54	0.003	6	54	0.009
16:00 - 17:00	6	54	0.006	6	54	0.012	6	54	0.018
17:00 - 18:00	6	54	0.006	6	54	0.003	6	54	0.009
18:00 - 19:00	6	54	0.003	6	54	0.000	6	54	0.003
19:00 - 20:00									
20:00 - 21:00									
21:00 - 22:00									
22:00 - 23:00									
23:00 - 24:00									
Total Rates:			0.045			0.060			0.105

This section displays the trip rate results based on the selected set of surveys and the selected count type (shown just above the table). It is split by three main columns, representing arrivals trips, departures trips, and total trips (arrivals plus departures). Within each of these main columns are three sub-columns. These display the number of survey days where count data is included (per time period), the average value of the selected trip rate calculation parameter (per time period), and the trip rate result (per time period). Total trip rates (the sum of the column) are also displayed at the foot of the table.

To obtain a trip rate, the average (mean) trip rate parameter value (TRP) is first calculated for all selected survey days that have count data available for the stated time period. The average (mean) number of arrivals, departures or totals (whichever applies) is also calculated (COUNT) for all selected survey days that have count data available for the stated time period. Then, the average count is divided by the average trip rate parameter value, and multiplied by the stated calculation factor (shown just above the table and abbreviated here as FACT). So, the method is: COUNT/TRP*FACT. Trip rates are then rounded to 3 decimal places.

WYG Executive Park, Avalon Way Leicester

Licence No: 705102

TRIP RATE for Land Use 03 - RESIDENTIAL/A - HOUSES PRIVATELY OWNED

MULTI-MODAL TOTAL RAIL PASSENGERS

Calculation factor: 1 DWELLS

BOLD print indicates peak (busiest) period

Time Range	ARRIVALS			DEPARTURES			TOTALS		
	No. Days	Ave. DWELLS	Trip Rate	No. Days	Ave. DWELLS	Trip Rate	No. Days	Ave. DWELLS	Trip Rate
00:00 - 01:00									
01:00 - 02:00									
02:00 - 03:00									
03:00 - 04:00									
04:00 - 05:00									
05:00 - 06:00									
06:00 - 07:00									
07:00 - 08:00	6	54	0.000	6	54	0.003	6	54	0.003
08:00 - 09:00	6	54	0.000	6	54	0.000	6	54	0.000
09:00 - 10:00	6	54	0.000	6	54	0.000	6	54	0.000
10:00 - 11:00	6	54	0.000	6	54	0.000	6	54	0.000
11:00 - 12:00	6	54	0.000	6	54	0.000	6	54	0.000
12:00 - 13:00	6	54	0.000	6	54	0.000	6	54	0.000
13:00 - 14:00	6	54	0.000	6	54	0.000	6	54	0.000
14:00 - 15:00	6	54	0.000	6	54	0.000	6	54	0.000
15:00 - 16:00	6	54	0.000	6	54	0.000	6	54	0.000
16:00 - 17:00	6	54	0.000	6	54	0.000	6	54	0.000
17:00 - 18:00	6	54	0.000	6	54	0.000	6	54	0.000
18:00 - 19:00	6	54	0.000	6	54	0.000	6	54	0.000
19:00 - 20:00									
20:00 - 21:00									
21:00 - 22:00									
22:00 - 23:00									
23:00 - 24:00									
Total Rates:			0.000			0.003			0.003

This section displays the trip rate results based on the selected set of surveys and the selected count type (shown just above the table). It is split by three main columns, representing arrivals trips, departures trips, and total trips (arrivals plus departures). Within each of these main columns are three sub-columns. These display the number of survey days where count data is included (per time period), the average value of the selected trip rate calculation parameter (per time period), and the trip rate result (per time period). Total trip rates (the sum of the column) are also displayed at the foot of the table.

To obtain a trip rate, the average (mean) trip rate parameter value (TRP) is first calculated for all selected survey days that have count data available for the stated time period. The average (mean) number of arrivals, departures or totals (whichever applies) is also calculated (COUNT) for all selected survey days that have count data available for the stated time period. Then, the average count is divided by the average trip rate parameter value, and multiplied by the stated calculation factor (shown just above the table and abbreviated here as FACT). So, the method is: COUNT/TRP*FACT. Trip rates are then rounded to 3 decimal places.

WYG Executive Park, Avalon Way Leicester

Licence No: 705102

TRIP RATE for Land Use 03 - RESIDENTIAL/A - HOUSES PRIVATELY OWNED

MULTI-MODAL COACH PASSENGERS

Calculation factor: 1 DWELLS

BOLD print indicates peak (busiest) period

Time Range	ARRIVALS			DEPARTURES			TOTALS		
	No. Days	Ave. DWELLS	Trip Rate	No. Days	Ave. DWELLS	Trip Rate	No. Days	Ave. DWELLS	Trip Rate
00:00 - 01:00									
01:00 - 02:00									
02:00 - 03:00									
03:00 - 04:00									
04:00 - 05:00									
05:00 - 06:00									
06:00 - 07:00									
07:00 - 08:00	6	54	0.000	6	54	0.000	6	54	0.000
08:00 - 09:00	6	54	0.000	6	54	0.006	6	54	0.006
09:00 - 10:00	6	54	0.000	6	54	0.000	6	54	0.000
10:00 - 11:00	6	54	0.000	6	54	0.000	6	54	0.000
11:00 - 12:00	6	54	0.000	6	54	0.000	6	54	0.000
12:00 - 13:00	6	54	0.000	6	54	0.000	6	54	0.000
13:00 - 14:00	6	54	0.000	6	54	0.000	6	54	0.000
14:00 - 15:00	6	54	0.000	6	54	0.000	6	54	0.000
15:00 - 16:00	6	54	0.006	6	54	0.000	6	54	0.006
16:00 - 17:00	6	54	0.000	6	54	0.000	6	54	0.000
17:00 - 18:00	6	54	0.000	6	54	0.000	6	54	0.000
18:00 - 19:00	6	54	0.000	6	54	0.000	6	54	0.000
19:00 - 20:00									
20:00 - 21:00									
21:00 - 22:00									
22:00 - 23:00									
23:00 - 24:00									
Total Rates:			0.006			0.006			0.012

This section displays the trip rate results based on the selected set of surveys and the selected count type (shown just above the table). It is split by three main columns, representing arrivals trips, departures trips, and total trips (arrivals plus departures). Within each of these main columns are three sub-columns. These display the number of survey days where count data is included (per time period), the average value of the selected trip rate calculation parameter (per time period), and the trip rate result (per time period). Total trip rates (the sum of the column) are also displayed at the foot of the table.

To obtain a trip rate, the average (mean) trip rate parameter value (TRP) is first calculated for all selected survey days that have count data available for the stated time period. The average (mean) number of arrivals, departures or totals (whichever applies) is also calculated (COUNT) for all selected survey days that have count data available for the stated time period. Then, the average count is divided by the average trip rate parameter value, and multiplied by the stated calculation factor (shown just above the table and abbreviated here as FACT). So, the method is: COUNT/TRP*FACT. Trip rates are then rounded to 3 decimal places.

WYG Executive Park, Avalon Way Leicester

Licence No: 705102

TRIP RATE for Land Use 03 - RESIDENTIAL/A - HOUSES PRIVATELY OWNED

MULTI-MODAL PUBLIC TRANSPORT USERS

Calculation factor: 1 DWELLS

BOLD print indicates peak (busiest) period

Time Range	ARRIVALS			DEPARTURES			TOTALS		
	No. Days	Ave. DWELLS	Trip Rate	No. Days	Ave. DWELLS	Trip Rate	No. Days	Ave. DWELLS	Trip Rate
00:00 - 01:00									
01:00 - 02:00									
02:00 - 03:00									
03:00 - 04:00									
04:00 - 05:00									
05:00 - 06:00									
06:00 - 07:00									
07:00 - 08:00	6	54	0.003	6	54	0.018	6	54	0.021
08:00 - 09:00	6	54	0.003	6	54	0.009	6	54	0.012
09:00 - 10:00	6	54	0.003	6	54	0.003	6	54	0.006
10:00 - 11:00	6	54	0.006	6	54	0.012	6	54	0.018
11:00 - 12:00	6	54	0.006	6	54	0.003	6	54	0.009
12:00 - 13:00	6	54	0.000	6	54	0.003	6	54	0.003
13:00 - 14:00	6	54	0.000	6	54	0.000	6	54	0.000
14:00 - 15:00	6	54	0.003	6	54	0.003	6	54	0.006
15:00 - 16:00	6	54	0.012	6	54	0.003	6	54	0.015
16:00 - 17:00	6	54	0.006	6	54	0.012	6	54	0.018
17:00 - 18:00	6	54	0.006	6	54	0.003	6	54	0.009
18:00 - 19:00	6	54	0.003	6	54	0.000	6	54	0.003
19:00 - 20:00									
20:00 - 21:00									
21:00 - 22:00									
22:00 - 23:00									
23:00 - 24:00									
Total Rates:			0.051			0.069			0.120

This section displays the trip rate results based on the selected set of surveys and the selected count type (shown just above the table). It is split by three main columns, representing arrivals trips, departures trips, and total trips (arrivals plus departures). Within each of these main columns are three sub-columns. These display the number of survey days where count data is included (per time period), the average value of the selected trip rate calculation parameter (per time period), and the trip rate result (per time period). Total trip rates (the sum of the column) are also displayed at the foot of the table.

To obtain a trip rate, the average (mean) trip rate parameter value (TRP) is first calculated for all selected survey days that have count data available for the stated time period. The average (mean) number of arrivals, departures or totals (whichever applies) is also calculated (COUNT) for all selected survey days that have count data available for the stated time period. Then, the average count is divided by the average trip rate parameter value, and multiplied by the stated calculation factor (shown just above the table and abbreviated here as FACT). So, the method is: COUNT/TRP*FACT. Trip rates are then rounded to 3 decimal places.

WYG Executive Park, Avalon Way Leicester

Licence No: 705102

TRIP RATE for Land Use 03 - RESIDENTIAL/A - HOUSES PRIVATELY OWNED

MULTI-MODAL TOTAL PEOPLE

Calculation factor: 1 DWELLS

BOLD print indicates peak (busiest) period

Total People to Total Vehicles ratio (all time periods and directions): 1.60

Time Range	ARRIVALS			DEPARTURES			TOTALS		
	No. Days	Ave. DWELLS	Trip Rate	No. Days	Ave. DWELLS	Trip Rate	No. Days	Ave. DWELLS	Trip Rate
00:00 - 01:00									
01:00 - 02:00									
02:00 - 03:00									
03:00 - 04:00									
04:00 - 05:00									
05:00 - 06:00									
06:00 - 07:00									
07:00 - 08:00	6	54	0.120	6	54	0.374	6	54	0.494
08:00 - 09:00	6	54	0.230	6	54	0.693	6	54	0.923
09:00 - 10:00	6	54	0.255	6	54	0.325	6	54	0.580
10:00 - 11:00	6	54	0.307	6	54	0.426	6	54	0.733
11:00 - 12:00	6	54	0.298	6	54	0.344	6	54	0.642
12:00 - 13:00	6	54	0.328	6	54	0.353	6	54	0.681
13:00 - 14:00	6	54	0.322	6	54	0.325	6	54	0.647
14:00 - 15:00	6	54	0.294	6	54	0.301	6	54	0.595
15:00 - 16:00	6	54	0.601	6	54	0.313	6	54	0.914
16:00 - 17:00	6	54	0.509	6	54	0.390	6	54	0.899
17:00 - 18:00	6	54	0.617	6	54	0.368	6	54	0.985
18:00 - 19:00	6	54	0.362	6	54	0.242	6	54	0.604
19:00 - 20:00									
20:00 - 21:00									
21:00 - 22:00									
22:00 - 23:00									
23:00 - 24:00									
Total Rates:			4.243			4.454			8.697

This section displays the trip rate results based on the selected set of surveys and the selected count type (shown just above the table). It is split by three main columns, representing arrivals trips, departures trips, and total trips (arrivals plus departures). Within each of these main columns are three sub-columns. These display the number of survey days where count data is included (per time period), the average value of the selected trip rate calculation parameter (per time period), and the trip rate result (per time period). Total trip rates (the sum of the column) are also displayed at the foot of the table.

To obtain a trip rate, the average (mean) trip rate parameter value (TRP) is first calculated for all selected survey days that have count data available for the stated time period. The average (mean) number of arrivals, departures or totals (whichever applies) is also calculated (COUNT) for all selected survey days that have count data available for the stated time period. Then, the average count is divided by the average trip rate parameter value, and multiplied by the stated calculation factor (shown just above the table and abbreviated here as FACT). So, the method is: COUNT/TRP*FACT. Trip rates are then rounded to 3 decimal places.

WYG Executive Park, Avalon Way Leicester

Licence No: 705102

TRIP RATE for Land Use 03 - RESIDENTIAL/A - HOUSES PRIVATELY OWNED

MULTI-MODAL CARS

Calculation factor: 1 DWELLS

BOLD print indicates peak (busiest) period

Time Range	ARRIVALS			DEPARTURES			TOTALS		
	No. Days	Ave. DWELLS	Trip Rate	No. Days	Ave. DWELLS	Trip Rate	No. Days	Ave. DWELLS	Trip Rate
00:00 - 01:00									
01:00 - 02:00									
02:00 - 03:00									
03:00 - 04:00									
04:00 - 05:00									
05:00 - 06:00									
06:00 - 07:00									
07:00 - 08:00	6	54	0.061	6	54	0.215	6	54	0.276
08:00 - 09:00	6	54	0.123	6	54	0.304	6	54	0.427
09:00 - 10:00	6	54	0.147	6	54	0.181	6	54	0.328
10:00 - 11:00	6	54	0.175	6	54	0.224	6	54	0.399
11:00 - 12:00	6	54	0.190	6	54	0.199	6	54	0.389
12:00 - 13:00	6	54	0.199	6	54	0.199	6	54	0.398
13:00 - 14:00	6	54	0.166	6	54	0.199	6	54	0.365
14:00 - 15:00	6	54	0.178	6	54	0.160	6	54	0.338
15:00 - 16:00	6	54	0.264	6	54	0.172	6	54	0.436
16:00 - 17:00	6	54	0.267	6	54	0.175	6	54	0.442
17:00 - 18:00	6	54	0.331	6	54	0.178	6	54	0.509
18:00 - 19:00	6	54	0.196	6	54	0.144	6	54	0.340
19:00 - 20:00									
20:00 - 21:00									
21:00 - 22:00									
22:00 - 23:00									
23:00 - 24:00									
Total Rates:			2.297			2.350			4.647

This section displays the trip rate results based on the selected set of surveys and the selected count type (shown just above the table). It is split by three main columns, representing arrivals trips, departures trips, and total trips (arrivals plus departures). Within each of these main columns are three sub-columns. These display the number of survey days where count data is included (per time period), the average value of the selected trip rate calculation parameter (per time period), and the trip rate result (per time period). Total trip rates (the sum of the column) are also displayed at the foot of the table.

To obtain a trip rate, the average (mean) trip rate parameter value (TRP) is first calculated for all selected survey days that have count data available for the stated time period. The average (mean) number of arrivals, departures or totals (whichever applies) is also calculated (COUNT) for all selected survey days that have count data available for the stated time period. Then, the average count is divided by the average trip rate parameter value, and multiplied by the stated calculation factor (shown just above the table and abbreviated here as FACT). So, the method is: COUNT/TRP*FACT. Trip rates are then rounded to 3 decimal places.

WYG Executive Park, Avalon Way Leicester

Licence No: 705102

TRIP RATE for Land Use 03 - RESIDENTIAL/A - HOUSES PRIVATELY OWNED

MULTI-MODAL LGVS

Calculation factor: 1 DWELLS

BOLD print indicates peak (busiest) period

Time Range	ARRIVALS			DEPARTURES			TOTALS		
	No. Days	Ave. DWELLS	Trip Rate	No. Days	Ave. DWELLS	Trip Rate	No. Days	Ave. DWELLS	Trip Rate
00:00 - 01:00									
01:00 - 02:00									
02:00 - 03:00									
03:00 - 04:00									
04:00 - 05:00									
05:00 - 06:00									
06:00 - 07:00									
07:00 - 08:00	6	54	0.015	6	54	0.052	6	54	0.067
08:00 - 09:00	6	54	0.034	6	54	0.028	6	54	0.062
09:00 - 10:00	6	54	0.021	6	54	0.025	6	54	0.046
10:00 - 11:00	6	54	0.031	6	54	0.028	6	54	0.059
11:00 - 12:00	6	54	0.021	6	54	0.021	6	54	0.042
12:00 - 13:00	6	54	0.043	6	54	0.046	6	54	0.089
13:00 - 14:00	6	54	0.049	6	54	0.028	6	54	0.077
14:00 - 15:00	6	54	0.021	6	54	0.037	6	54	0.058
15:00 - 16:00	6	54	0.028	6	54	0.018	6	54	0.046
16:00 - 17:00	6	54	0.021	6	54	0.031	6	54	0.052
17:00 - 18:00	6	54	0.055	6	54	0.028	6	54	0.083
18:00 - 19:00	6	54	0.025	6	54	0.012	6	54	0.037
19:00 - 20:00									
20:00 - 21:00									
21:00 - 22:00									
22:00 - 23:00									
23:00 - 24:00									
Total Rates:			0.364			0.354			0.718

This section displays the trip rate results based on the selected set of surveys and the selected count type (shown just above the table). It is split by three main columns, representing arrivals trips, departures trips, and total trips (arrivals plus departures). Within each of these main columns are three sub-columns. These display the number of survey days where count data is included (per time period), the average value of the selected trip rate calculation parameter (per time period), and the trip rate result (per time period). Total trip rates (the sum of the column) are also displayed at the foot of the table.

To obtain a trip rate, the average (mean) trip rate parameter value (TRP) is first calculated for all selected survey days that have count data available for the stated time period. The average (mean) number of arrivals, departures or totals (whichever applies) is also calculated (COUNT) for all selected survey days that have count data available for the stated time period. Then, the average count is divided by the average trip rate parameter value, and multiplied by the stated calculation factor (shown just above the table and abbreviated here as FACT). So, the method is: COUNT/TRP*FACT. Trip rates are then rounded to 3 decimal places.

WYG Executive Park, Avalon Way Leicester

Licence No: 705102

TRIP RATE for Land Use 03 - RESIDENTIAL/A - HOUSES PRIVATELY OWNED

MULTI-MODAL MOTOR CYCLES

Calculation factor: **1 DWELLS**

BOLD print indicates peak (busiest) period

Time Range	ARRIVALS			DEPARTURES			TOTALS		
	No. Days	Ave. DWELLS	Trip Rate	No. Days	Ave. DWELLS	Trip Rate	No. Days	Ave. DWELLS	Trip Rate
00:00 - 01:00									
01:00 - 02:00									
02:00 - 03:00									
03:00 - 04:00									
04:00 - 05:00									
05:00 - 06:00									
06:00 - 07:00									
07:00 - 08:00	6	54	0.000	6	54	0.000	6	54	0.000
08:00 - 09:00	6	54	0.000	6	54	0.003	6	54	0.003
09:00 - 10:00	6	54	0.000	6	54	0.000	6	54	0.000
10:00 - 11:00	6	54	0.000	6	54	0.000	6	54	0.000
11:00 - 12:00	6	54	0.000	6	54	0.000	6	54	0.000
12:00 - 13:00	6	54	0.000	6	54	0.000	6	54	0.000
13:00 - 14:00	6	54	0.000	6	54	0.000	6	54	0.000
14:00 - 15:00	6	54	0.003	6	54	0.006	6	54	0.009
15:00 - 16:00	6	54	0.000	6	54	0.000	6	54	0.000
16:00 - 17:00	6	54	0.000	6	54	0.000	6	54	0.000
17:00 - 18:00	6	54	0.006	6	54	0.000	6	54	0.006
18:00 - 19:00	6	54	0.000	6	54	0.000	6	54	0.000
19:00 - 20:00									
20:00 - 21:00									
21:00 - 22:00									
22:00 - 23:00									
23:00 - 24:00									
Total Rates:			0.009			0.009			0.018

This section displays the trip rate results based on the selected set of surveys and the selected count type (shown just above the table). It is split by three main columns, representing arrivals trips, departures trips, and total trips (arrivals plus departures). Within each of these main columns are three sub-columns. These display the number of survey days where count data is included (per time period), the average value of the selected trip rate calculation parameter (per time period), and the trip rate result (per time period). Total trip rates (the sum of the column) are also displayed at the foot of the table.

To obtain a trip rate, the average (mean) trip rate parameter value (TRP) is first calculated for all selected survey days that have count data available for the stated time period. The average (mean) number of arrivals, departures or totals (whichever applies) is also calculated (COUNT) for all selected survey days that have count data available for the stated time period. Then, the average count is divided by the average trip rate parameter value, and multiplied by the stated calculation factor (shown just above the table and abbreviated here as FACT). So, the method is: COUNT/TRP*FACT. Trip rates are then rounded to 3 decimal places.

Appendix J – Traffic Calculations

PERCENTAGE DISTRIBUTION OF DEVELOPMENT TRIPS

AM
PM
AM
PM

AM
PM

AM
PM

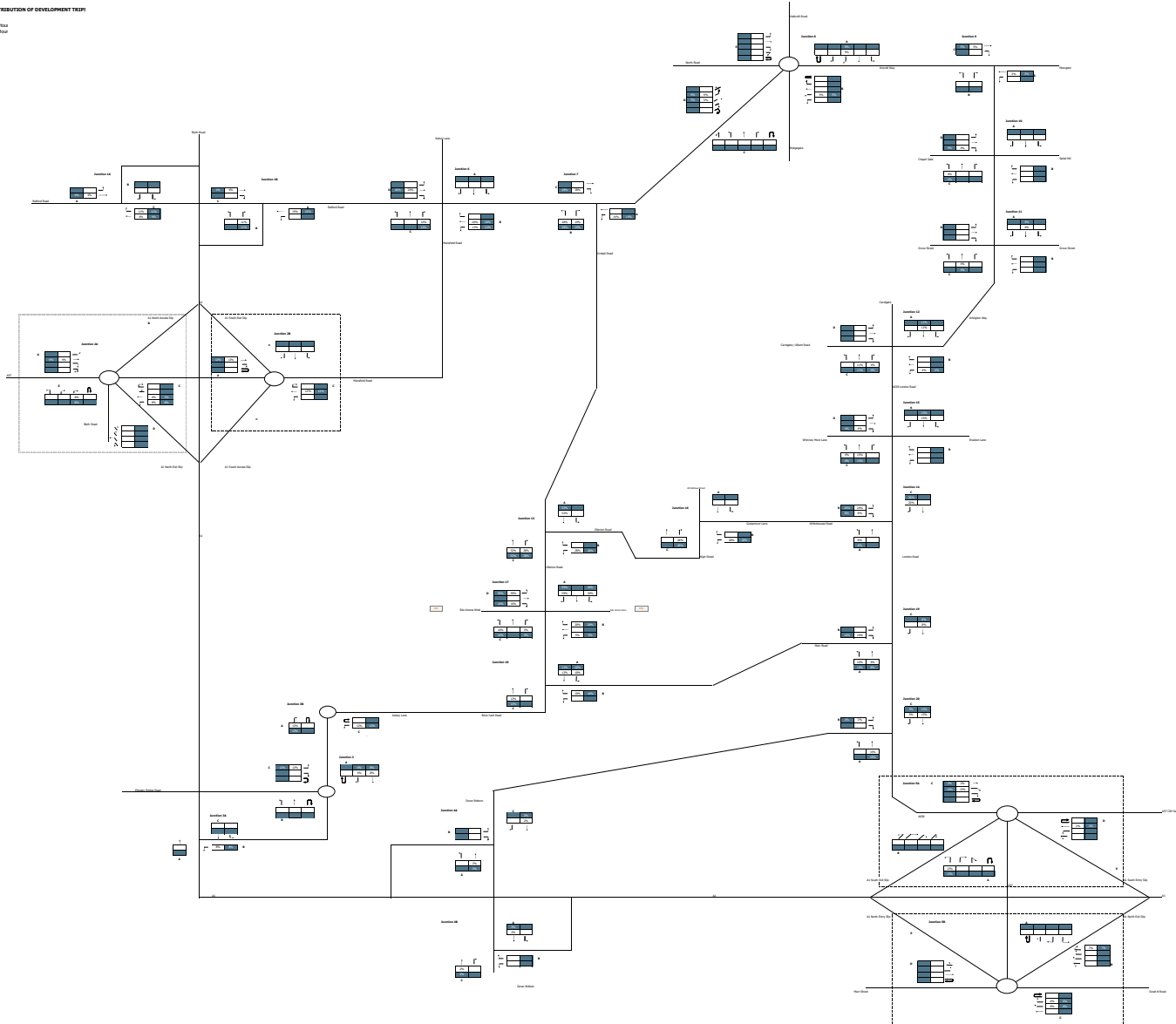

ORGANISATIONAL DEVELOPMENT TRIPS - 1320 Dwellings (PC14)

KEY

1	1st Floor
2	2nd Floor
3	3rd Floor
4	4th Floor
5	5th Floor
6	6th Floor
7	7th Floor
8	8th Floor
9	9th Floor
10	10th Floor
11	11th Floor
12	12th Floor
13	13th Floor
14	14th Floor
15	15th Floor
16	16th Floor
17	17th Floor
18	18th Floor
19	19th Floor
20	20th Floor
21	21st Floor
22	22nd Floor
23	23rd Floor
24	24th Floor
25	25th Floor
26	26th Floor
27	27th Floor
28	28th Floor
29	29th Floor
30	30th Floor
31	31st Floor
32	32nd Floor
33	33rd Floor
34	34th Floor
35	35th Floor
36	36th Floor
37	37th Floor
38	38th Floor
39	39th Floor
40	40th Floor
41	41st Floor
42	42nd Floor
43	43rd Floor
44	44th Floor
45	45th Floor
46	46th Floor
47	47th Floor
48	48th Floor
49	49th Floor
50	50th Floor
51	51st Floor
52	52nd Floor
53	53rd Floor
54	54th Floor
55	55th Floor
56	56th Floor
57	57th Floor
58	58th Floor
59	59th Floor
60	60th Floor
61	61st Floor
62	62nd Floor
63	63rd Floor
64	64th Floor
65	65th Floor
66	66th Floor
67	67th Floor
68	68th Floor
69	69th Floor
70	70th Floor
71	71st Floor
72	72nd Floor
73	73rd Floor
74	74th Floor
75	75th Floor
76	76th Floor
77	77th Floor
78	78th Floor
79	79th Floor
80	80th Floor
81	81st Floor
82	82nd Floor
83	83rd Floor
84	84th Floor
85	85th Floor
86	86th Floor
87	87th Floor
88	88th Floor
89	89th Floor
90	90th Floor
91	91st Floor
92	92nd Floor
93	93rd Floor
94	94th Floor
95	95th Floor
96	96th Floor
97	97th Floor
98	98th Floor
99	99th Floor
100	100th Floor

Legend:

- 1st Floor Peak Hour
- 2nd Floor Peak Hour

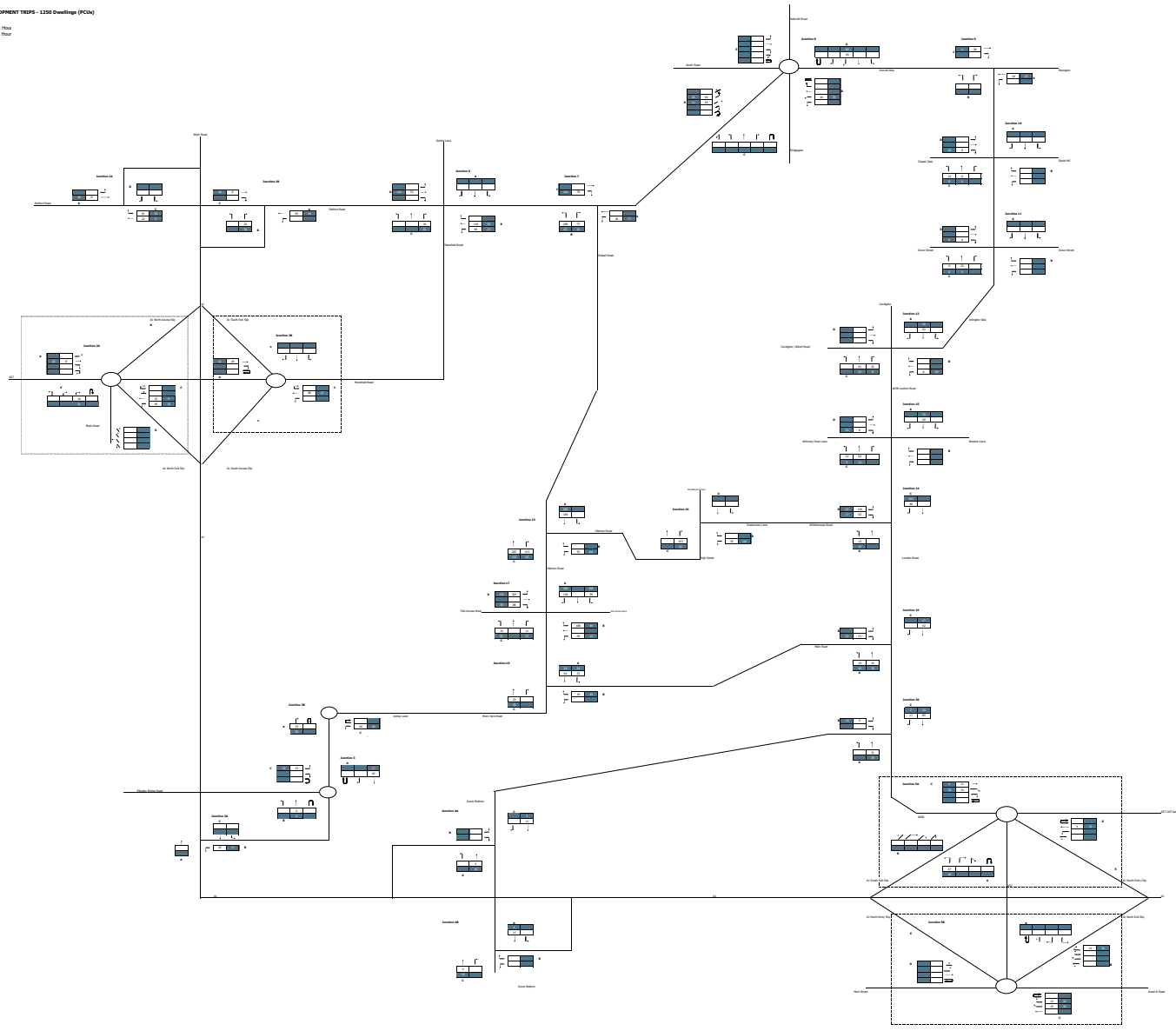

ORISSA DEVELOPMENT TRIPS - 930 Overlap (PCNs)

PCN

1	2	3	4	5	6	7	8	9	10	11	12	13	14	15	16	17	18	19	20	21	22	23	24	25	26	27	28	29	30	31	32	33	34	35	36	37	38	39	40	41	42	43	44	45	46	47	48	49	50	51	52	53	54	55	56	57	58	59	60	61	62	63	64	65	66	67	68	69	70	71	72	73	74	75	76	77	78	79	80	81	82	83	84	85	86	87	88	89	90	91	92	93	94	95	96	97	98	99	100
---	---	---	---	---	---	---	---	---	----	----	----	----	----	----	----	----	----	----	----	----	----	----	----	----	----	----	----	----	----	----	----	----	----	----	----	----	----	----	----	----	----	----	----	----	----	----	----	----	----	----	----	----	----	----	----	----	----	----	----	----	----	----	----	----	----	----	----	----	----	----	----	----	----	----	----	----	----	----	----	----	----	----	----	----	----	----	----	----	----	----	----	----	----	----	----	----	----	----	-----

PCN

1	2	3	4	5	6	7	8	9	10	11	12	13	14	15	16	17	18	19	20	21	22	23	24	25	26	27	28	29	30	31	32	33	34	35	36	37	38	39	40	41	42	43	44	45	46	47	48	49	50	51	52	53	54	55	56	57	58	59	60	61	62	63	64	65	66	67	68	69	70	71	72	73	74	75	76	77	78	79	80	81	82	83	84	85	86	87	88	89	90	91	92	93	94	95	96	97	98	99	100
---	---	---	---	---	---	---	---	---	----	----	----	----	----	----	----	----	----	----	----	----	----	----	----	----	----	----	----	----	----	----	----	----	----	----	----	----	----	----	----	----	----	----	----	----	----	----	----	----	----	----	----	----	----	----	----	----	----	----	----	----	----	----	----	----	----	----	----	----	----	----	----	----	----	----	----	----	----	----	----	----	----	----	----	----	----	----	----	----	----	----	----	----	----	----	----	----	----	----	-----

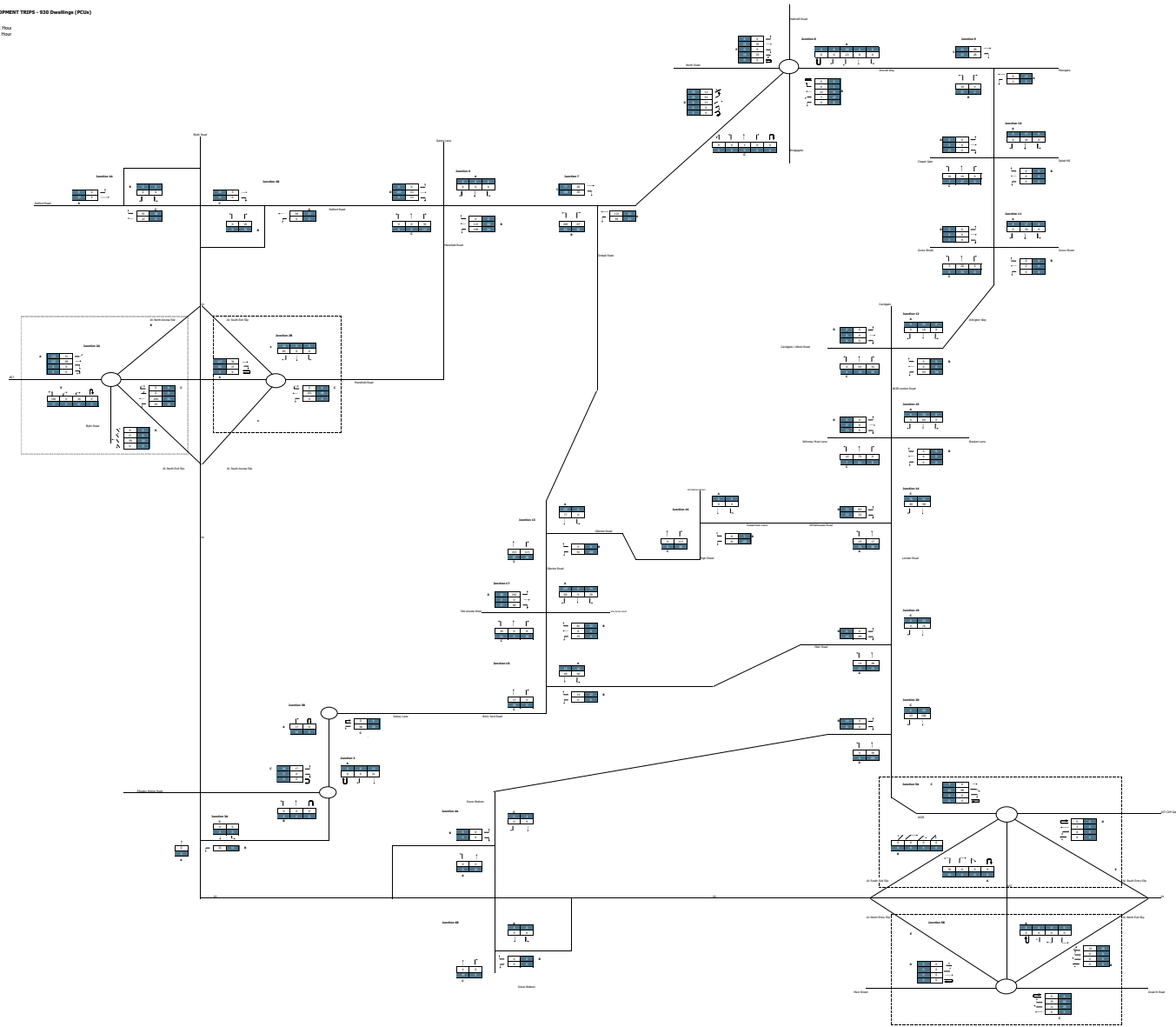

ORISSA DEVELOPMENT TRIPS - 930 Overlap (PCNs)

PCN

1	2	3	4	5	6	7	8	9	10	11	12	13	14	15	16	17	18	19	20	21	22	23	24	25	26	27	28	29	30	31	32	33	34	35	36	37	38	39	40	41	42	43	44	45	46	47	48	49	50	51	52	53	54	55	56	57	58	59	60	61	62	63	64	65	66	67	68	69	70	71	72	73	74	75	76	77	78	79	80	81	82	83	84	85	86	87	88	89	90	91	92	93	94	95	96	97	98	99	100
---	---	---	---	---	---	---	---	---	----	----	----	----	----	----	----	----	----	----	----	----	----	----	----	----	----	----	----	----	----	----	----	----	----	----	----	----	----	----	----	----	----	----	----	----	----	----	----	----	----	----	----	----	----	----	----	----	----	----	----	----	----	----	----	----	----	----	----	----	----	----	----	----	----	----	----	----	----	----	----	----	----	----	----	----	----	----	----	----	----	----	----	----	----	----	----	----	----	----	-----

PCN

1	2	3	4	5	6	7	8	9	10	11	12	13	14	15	16	17	18	19	20	21	22	23	24	25	26	27	28	29	30	31	32	33	34	35	36	37	38	39	40	41	42	43	44	45	46	47	48	49	50	51	52	53	54	55	56	57	58	59	60	61	62	63	64	65	66	67	68	69	70	71	72	73	74	75	76	77	78	79	80	81	82	83	84	85	86	87	88	89	90	91	92	93	94	95	96	97	98	99	100
---	---	---	---	---	---	---	---	---	----	----	----	----	----	----	----	----	----	----	----	----	----	----	----	----	----	----	----	----	----	----	----	----	----	----	----	----	----	----	----	----	----	----	----	----	----	----	----	----	----	----	----	----	----	----	----	----	----	----	----	----	----	----	----	----	----	----	----	----	----	----	----	----	----	----	----	----	----	----	----	----	----	----	----	----	----	----	----	----	----	----	----	----	----	----	----	----	----	----	-----

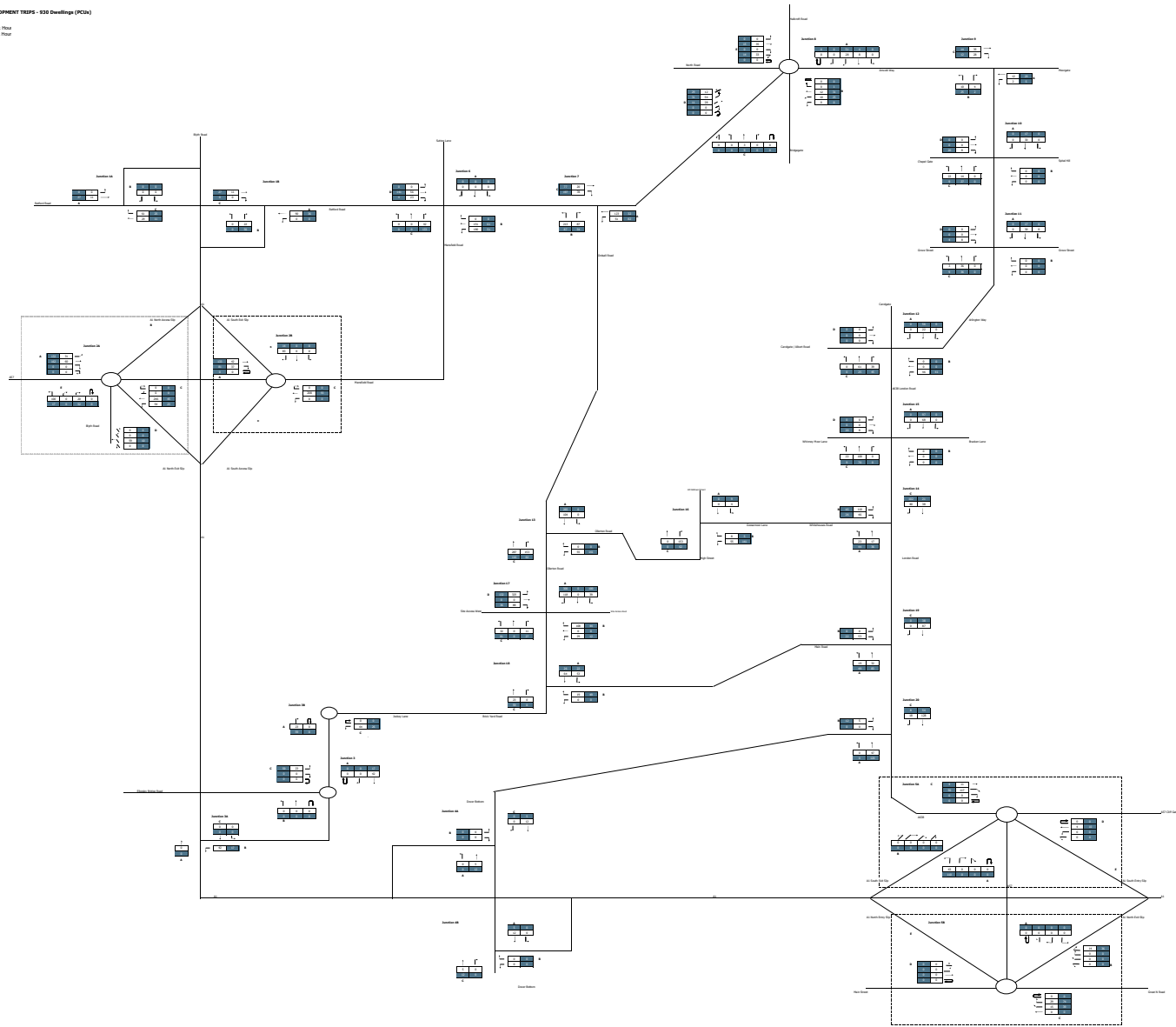

2021 BASE + COMMITTED (FCU)

FCU
Lighting Peak Hour
Cooling Peak Hour

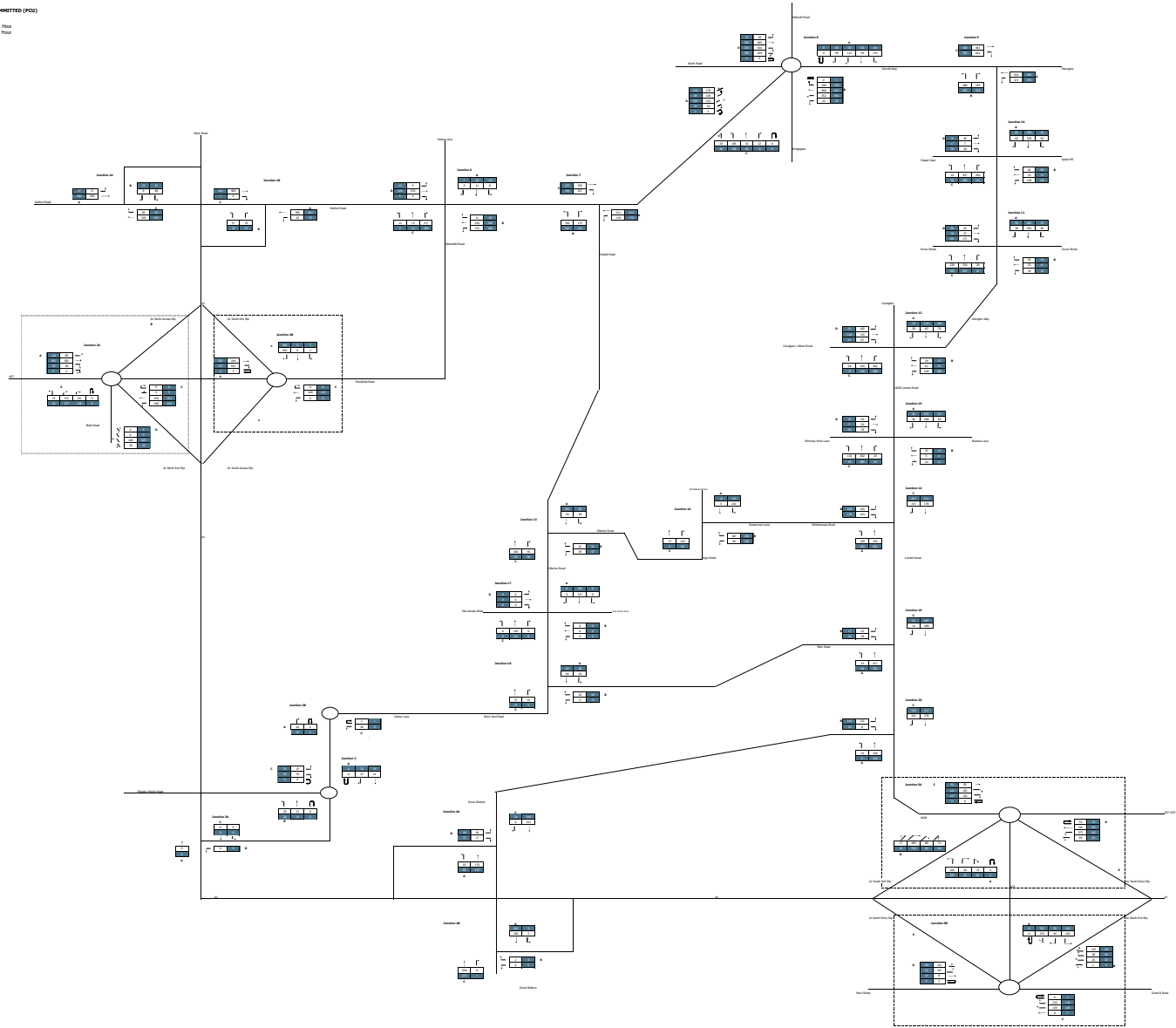

2021 BASE + COMMITTED + 930 DWELLINGS AT ORSALL DEVELOPMENT (PCS)

2021
Existing Peak Hour
Committed Peak Hour

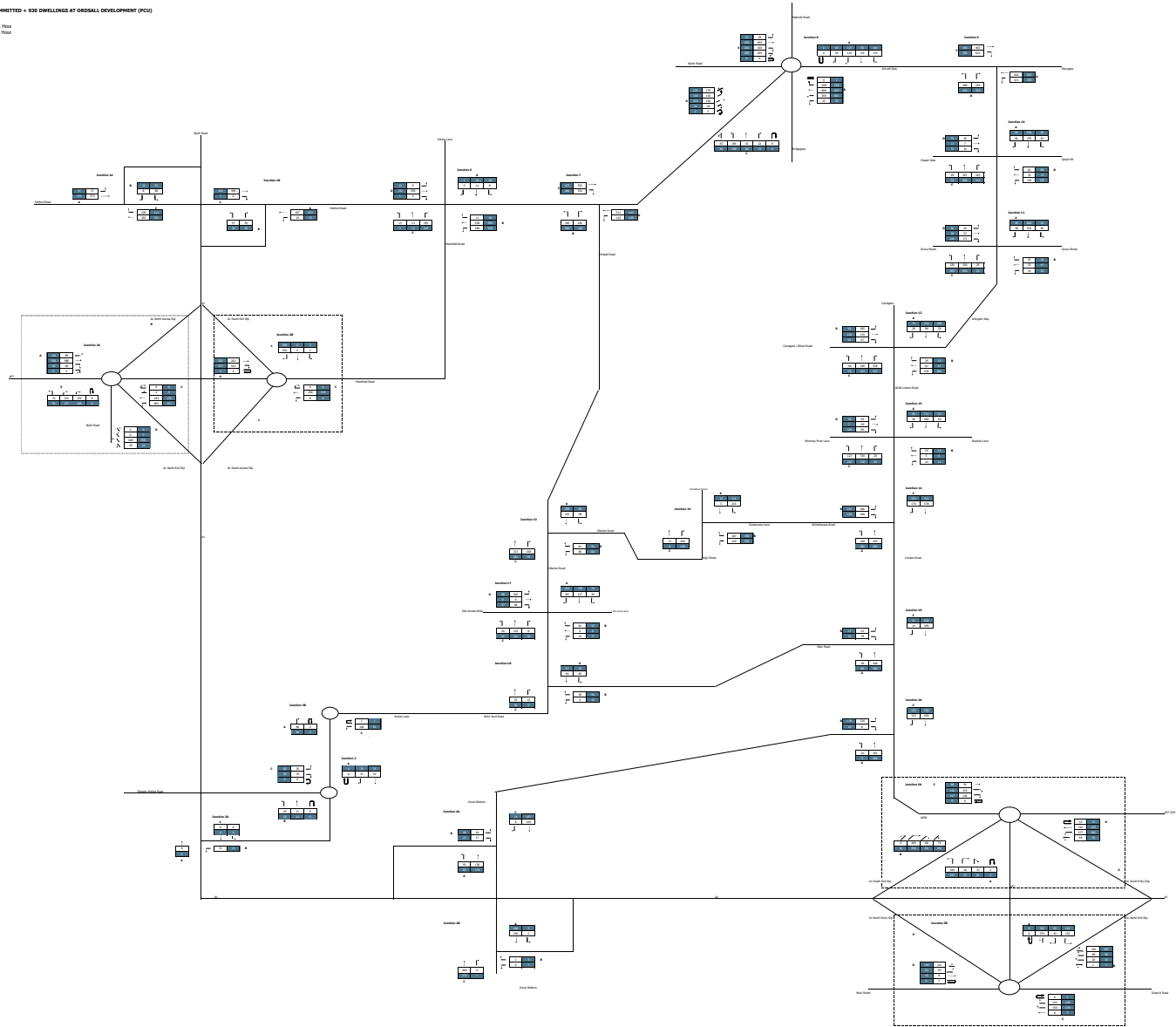

2021
Existing Peak Hour
Committed Peak Hour

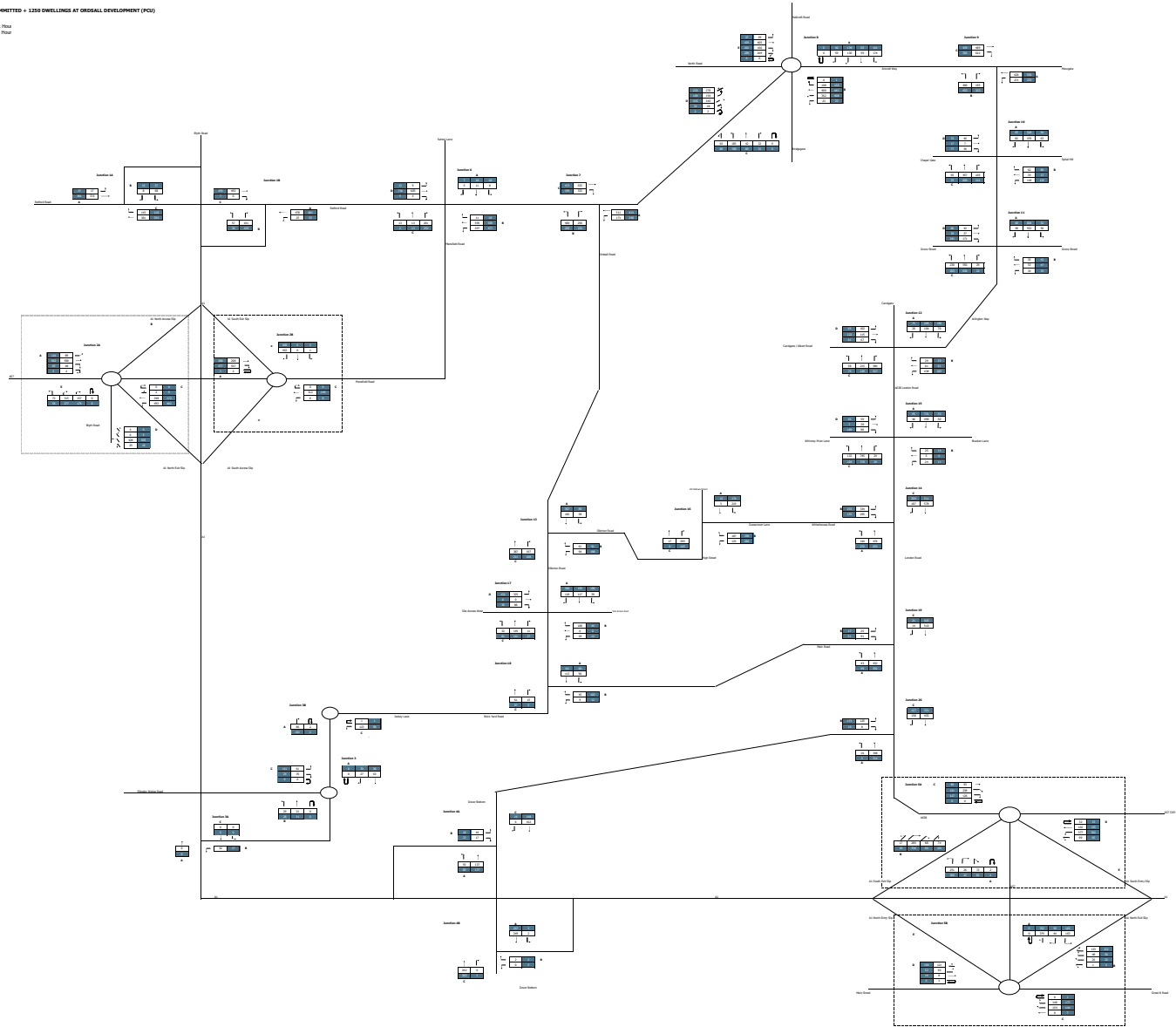

2038 BASE (PGU)
RTS
Morning Peak Hour
Evening Peak Hour

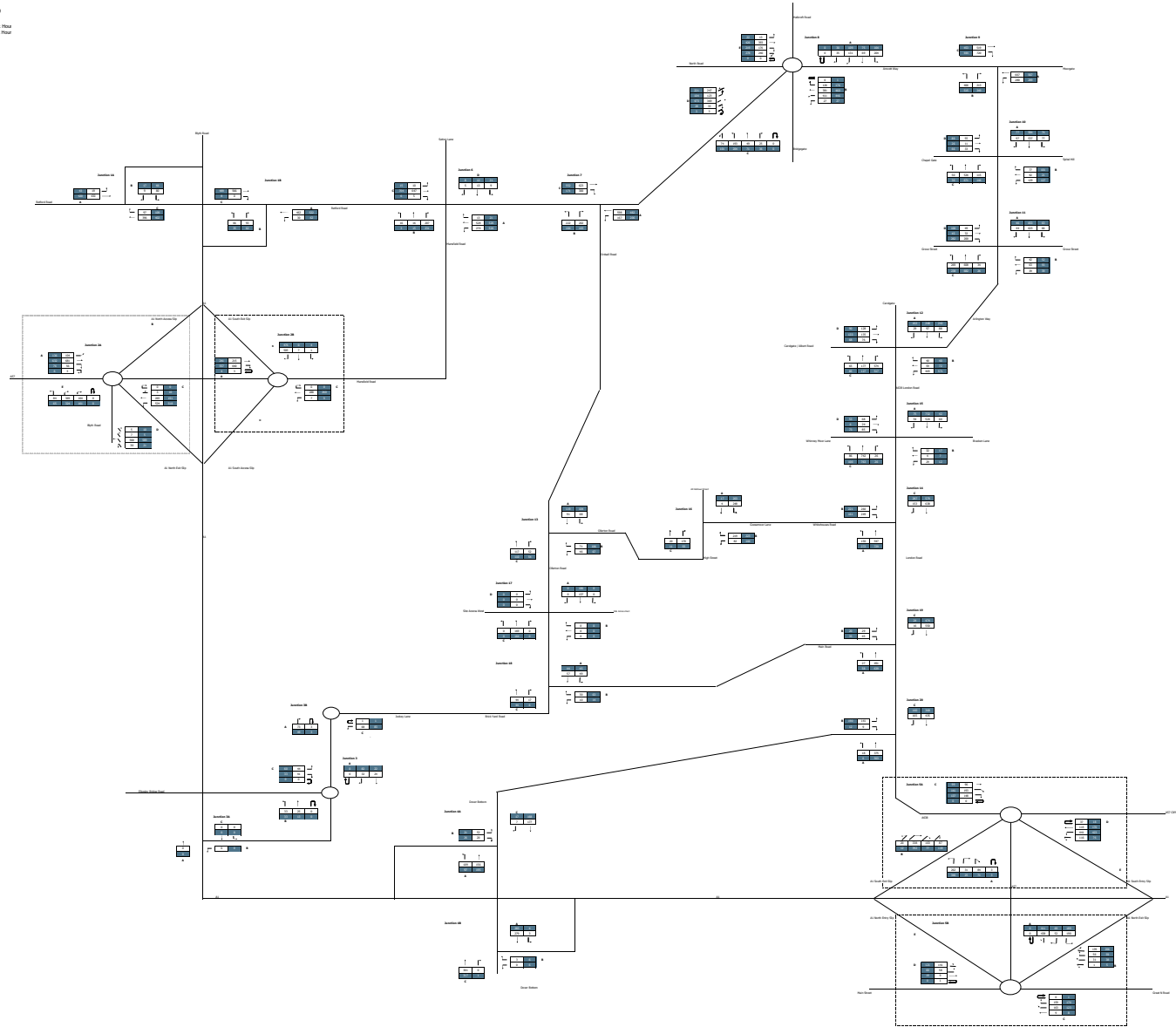

2038 BASE + COMMITTED (FCU)

FCU
Lighting Peak Hour
Cooling Peak Hour

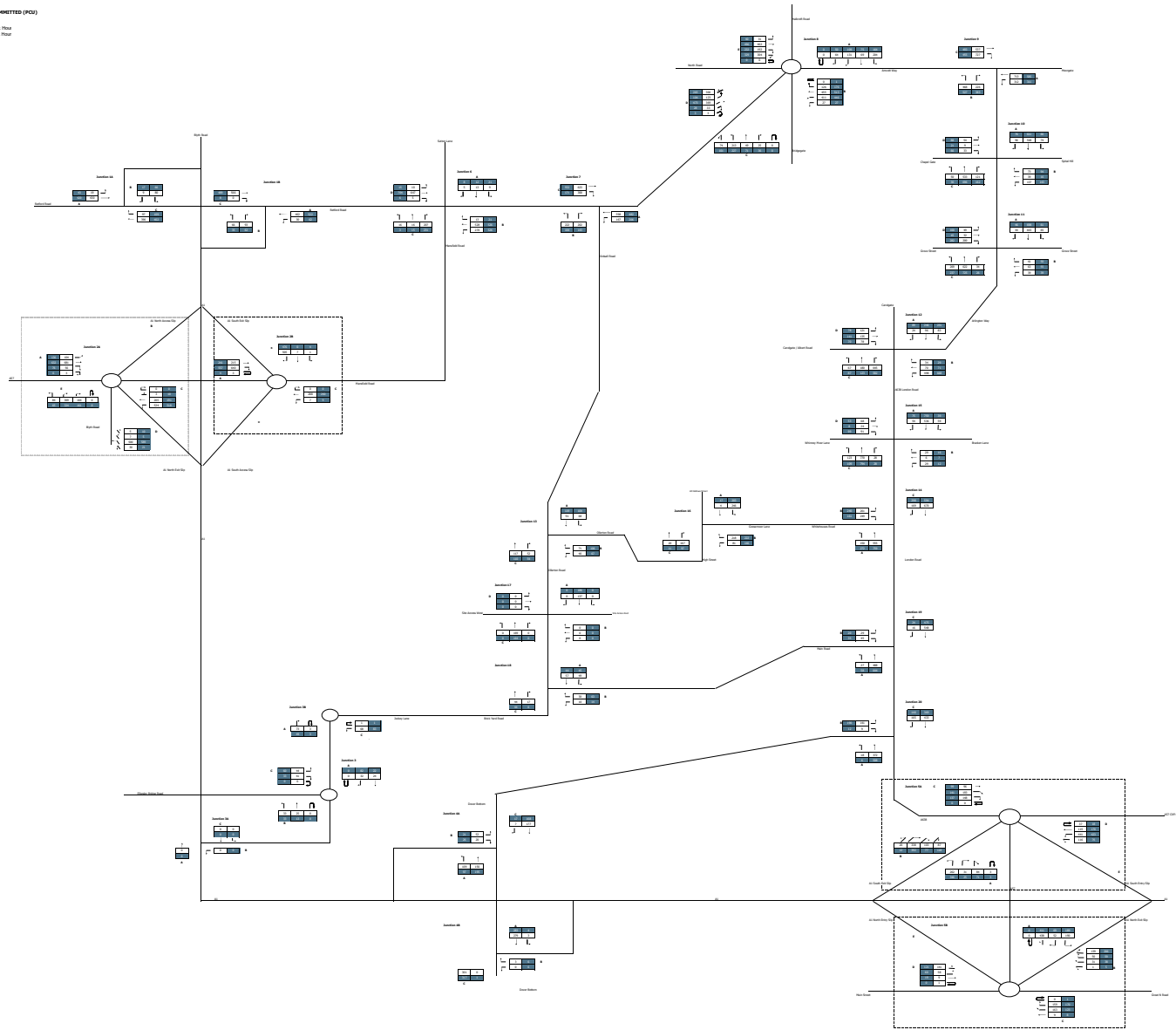

2038 BASE + COMMITTED + OPTIONAL (PCU)

PCU
■ Morning Peak Hour
■ Evening Peak Hour

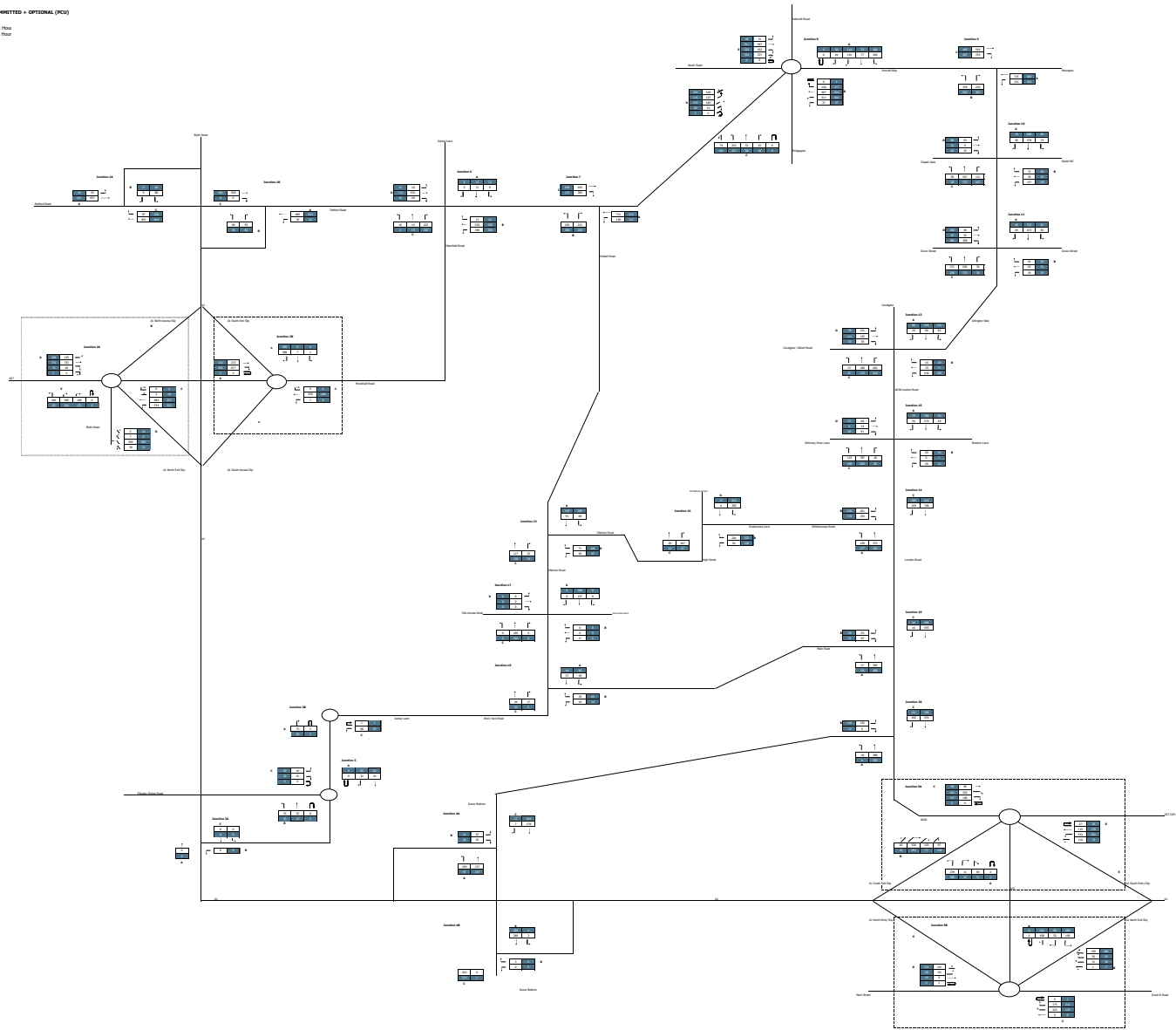

PCU
Morning Peak Hour
Evening Peak Hour

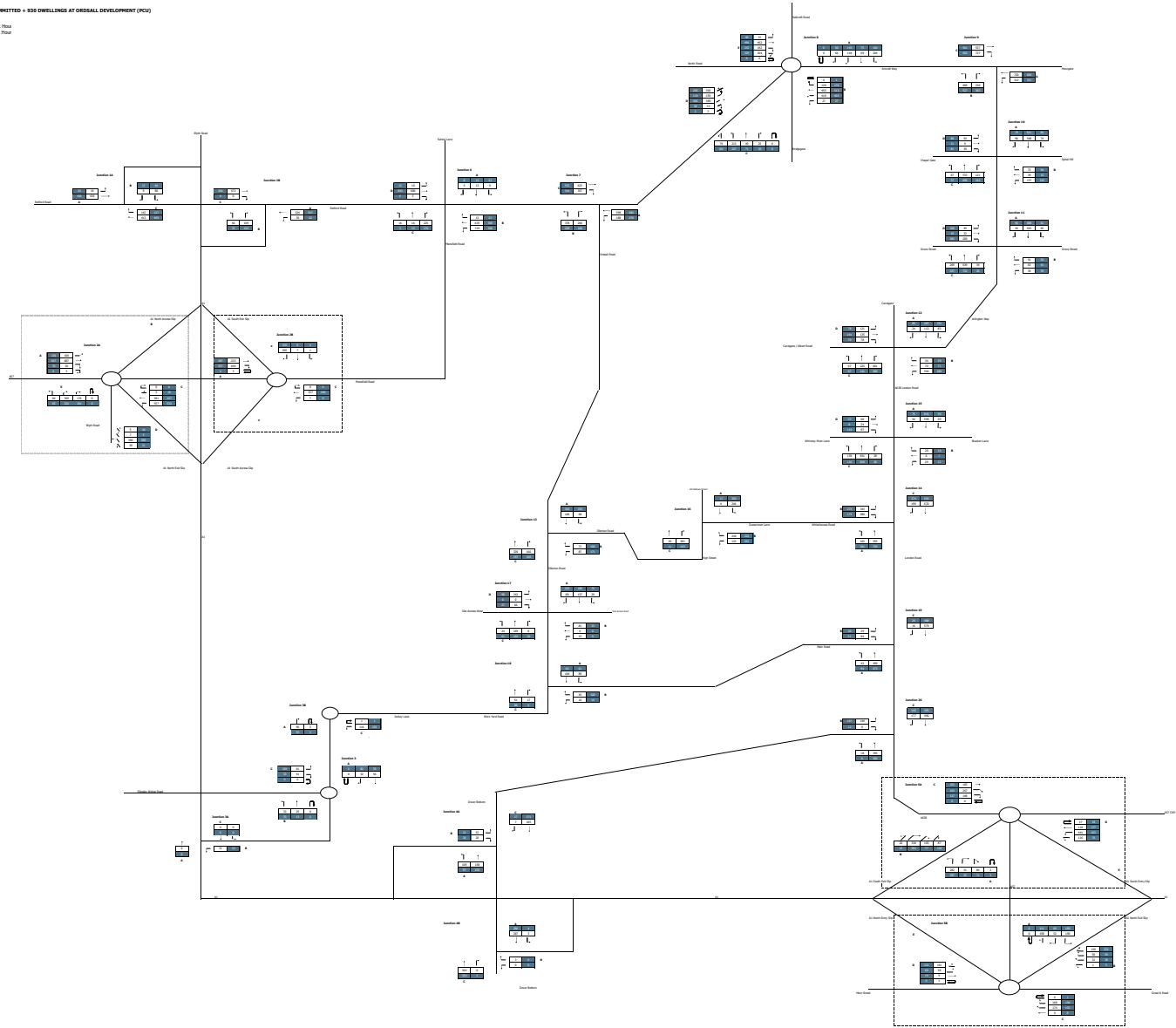

PCU
Morning Peak Hour
Evening Peak Hour

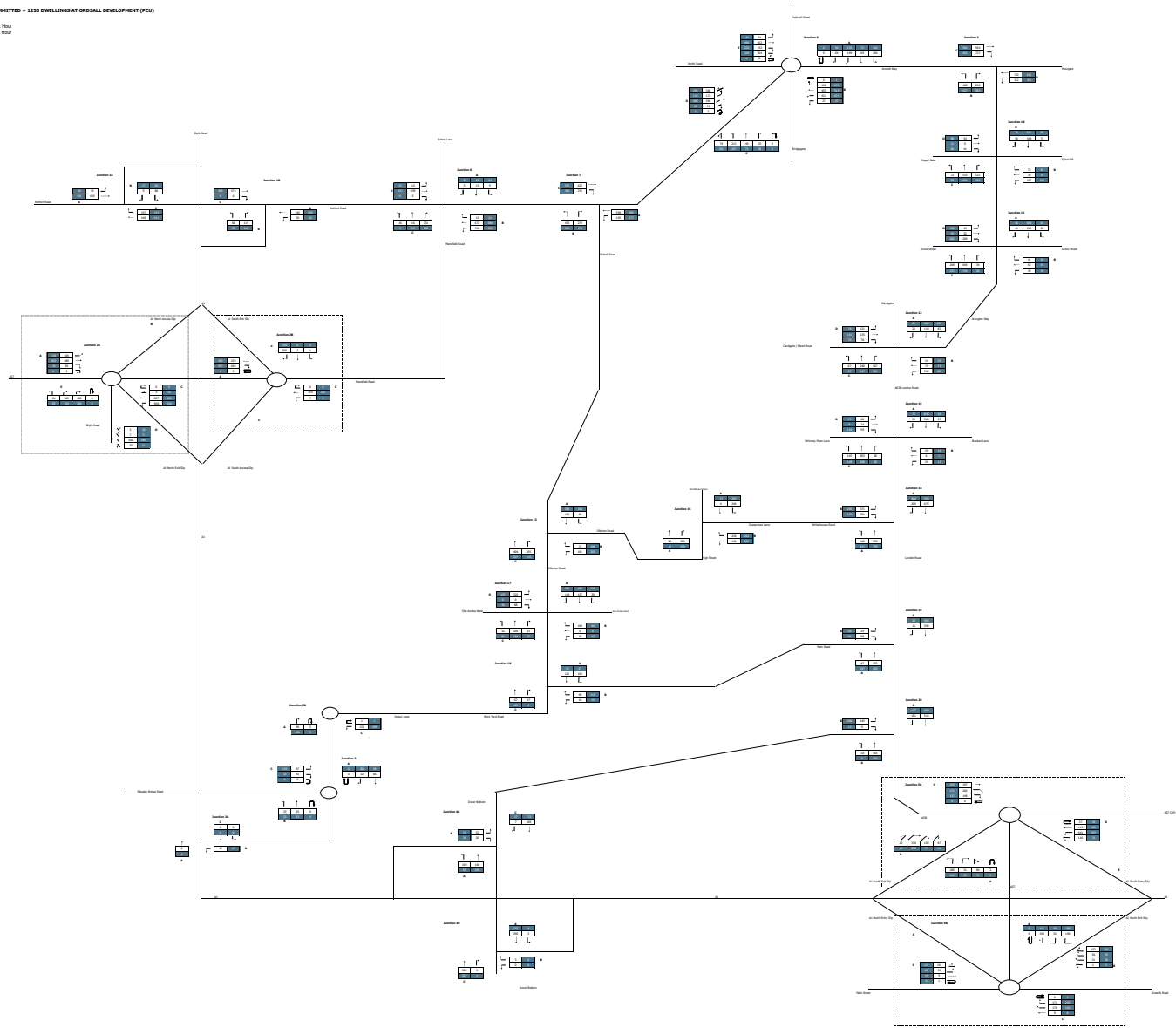

2038 BASE + COMMITTED + OPTIONAL + 930 DWELLINGS AT ORSAYAL DEVELOPMENT (PCU)

2038
2038
2038

2038
2038
2038

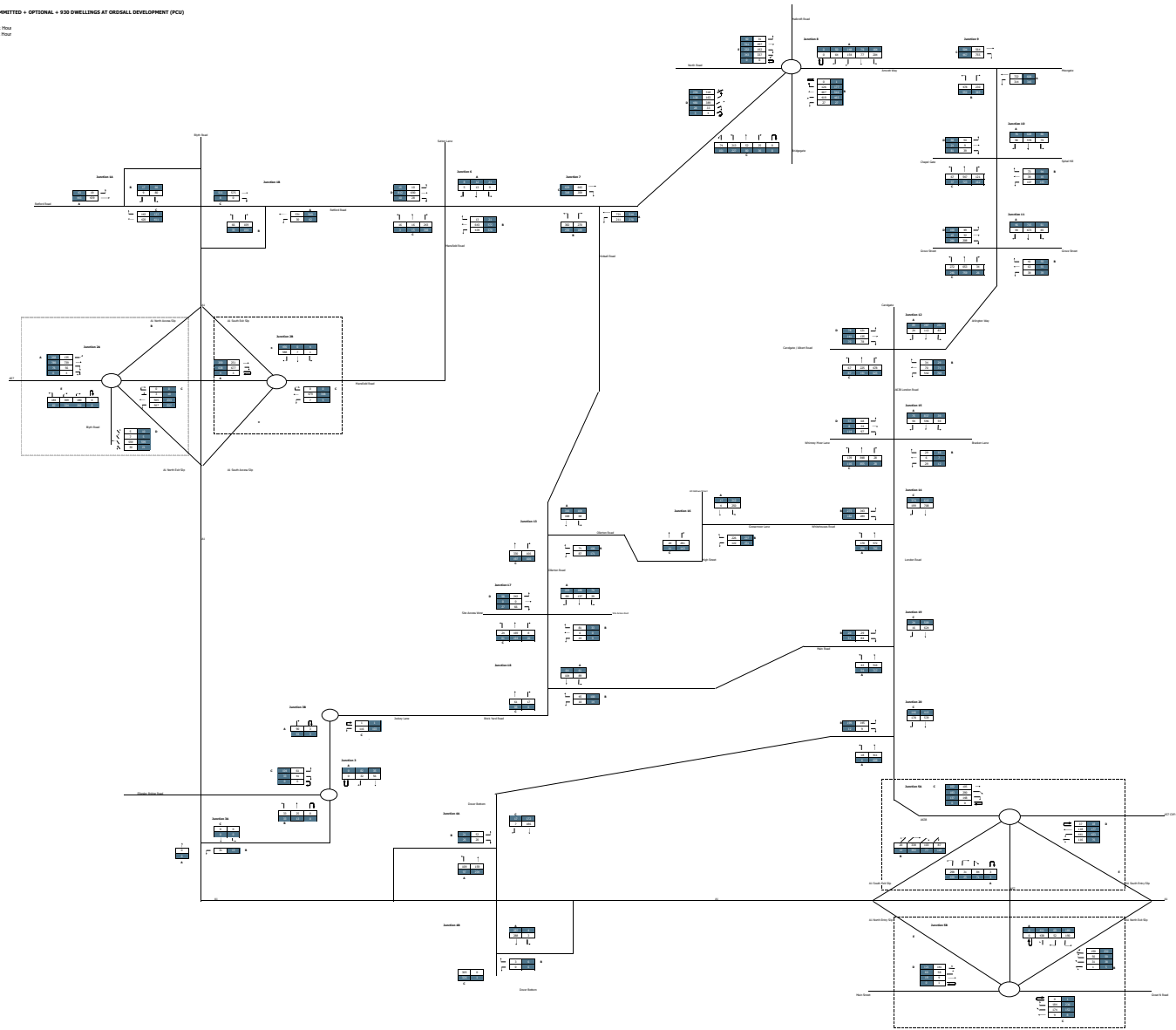

2038 BASE + COMMITTED + OPTIONAL + 1250 DWELLINGS AT ORISALL DEVELOPMENT (PCU)

PCU
Morning Peak Hour
Evening Peak Hour

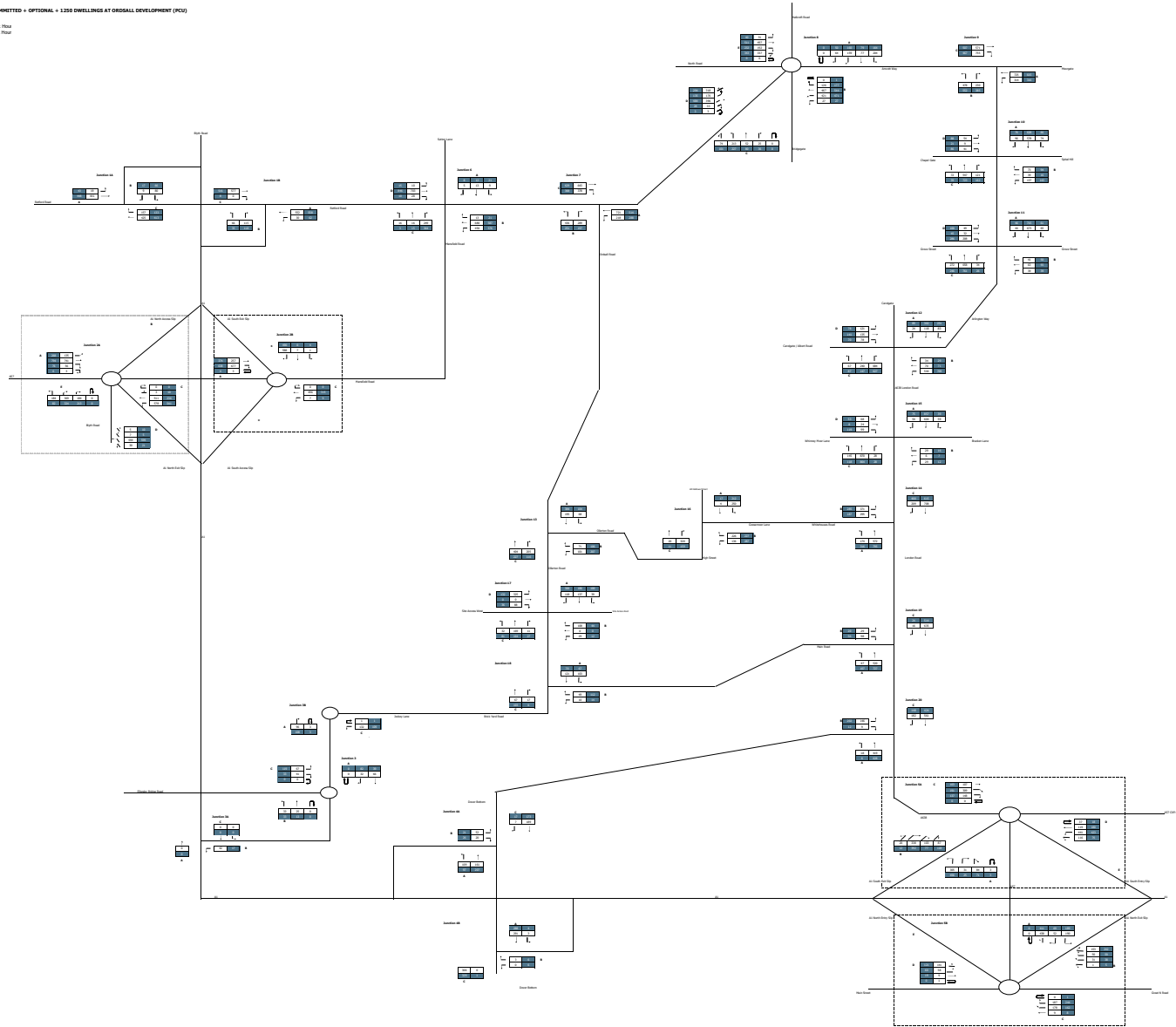

Appendix K – Capacity Assessments

(available on request)

Appendix L – Mitigation

(capacity assessments available on request)



Key

- Proposed Layout & Road Markings
- - - Existing Layout & Road Markings

PROPOSED CHANGE TO LANE ALLOCATION

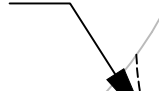

A1(N)/A1(S)
A57 E A57
A614

PROPOSED WIDENING TO ALLOW TWO VEHICLE EXIT



7.4m

Ward Bdy

ED & Ward Bdy

44.4m

Blyth Road

A 614

PRELIMINARY ISSUE

Rev	Description	Date	Des	CHK	App
P01	PRELIMINARY FIRST ISSUE	23.05.2022	NJ	RJH	RJH

Document Control

Issuing Office
 Tetra Tech Leicester
 Executive Park, Avon Way, Anstey,
 Leicester, United Kingdom, LE7 7GR
 Tel: +44 (0)11 6234 8000
 www.tetratech.europa.com

Client
BASSETLAW DISTRICT COUNCIL

Project Name
ORDSALL, RETFORD

Sheet Title
**PROPOSED MITIGATION AT THE
APLEYHEAD INTERCHANGE RETFORD**

TTE Project Number	Drawn By	Date	Checked By	Date	Approved By	Date	Scale @ A3	Suitability
B023665	NJ	May '22	RJH	May '22	RJH	May '22	1:500	S0

Client Project Number	Originator	Volume	System Level/Location	Type/Code	Role	Number	Revision
PRJ01	TTE	00	ZZ	DR	O	00013	P01

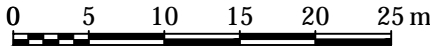

SCALE 1:500

N:\Projects\B023665 - Ordsall, Retford\07 - AutoCAD & GIS\01 - DWGs\B023665-SK0001-SK0002-Junction 6 7 9 & Junction 14 Rev P02.dwg

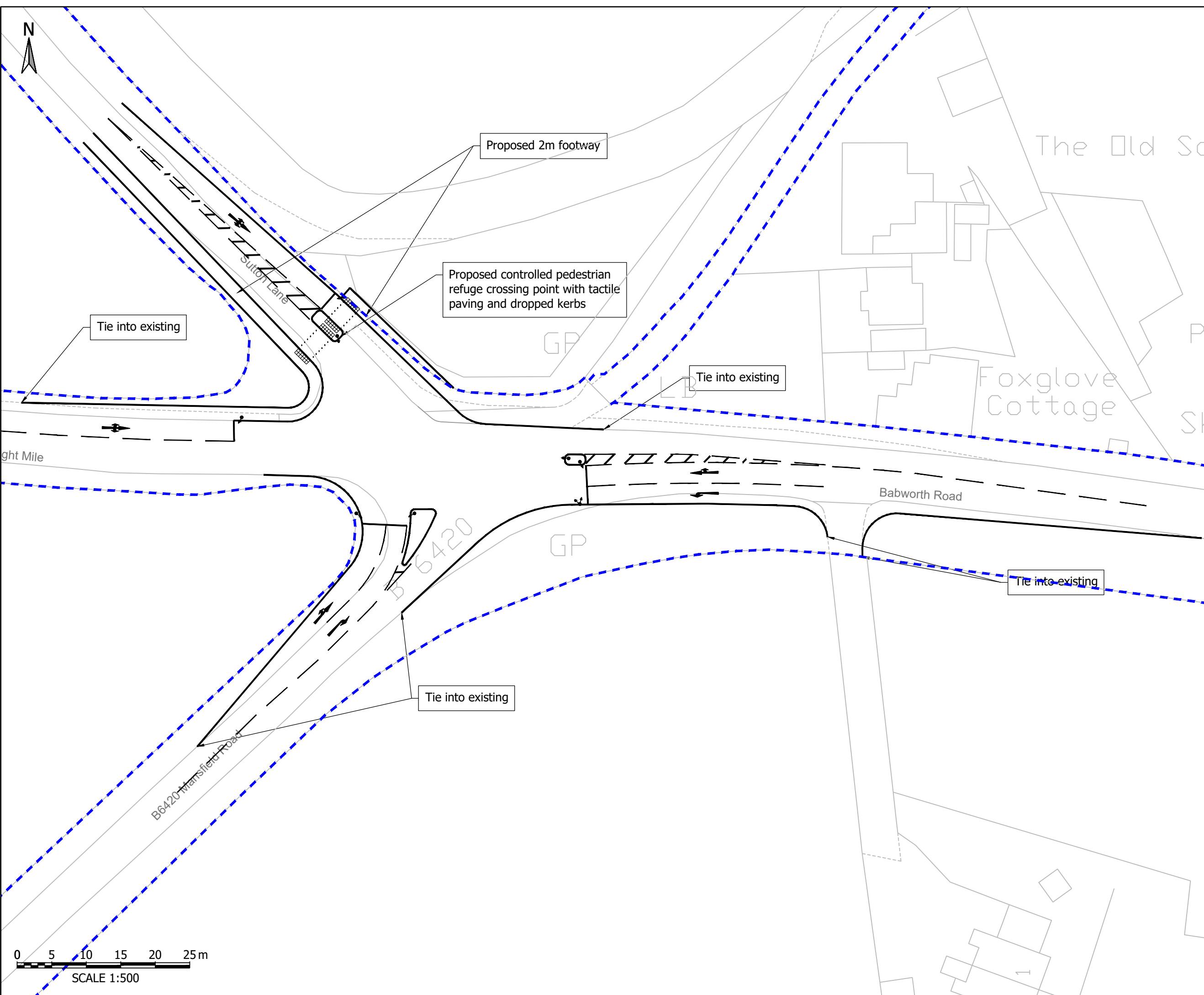

- Notes:**
- General**
1. Do not scale from drawing.
 2. All dimensions are in metres, unless stated otherwise.
 3. This drawing is to be read & printed in colour.
 4. This drawing is for illustrative purposes only.

Disclaimer

1. The information contained in this drawing is based on a combination of OS and data provided by others and Tetra Tech shall not be liable for any inaccuracies or deficiencies.

- Key**
- NEW KERB LINE
 - - - ADOPTED HIGHWAY AREA

PRELIMINARY ISSUE

Rev	Description	Date	Drawn	Appr
P02	AMENDED TO ADDRESS NCC COMMENTS	07.02.2022	NJ	BG
P01	PRELIMINARY FIRST ISSUE	18.08.2021	SJR	BM

Issuing Office
Tetra Tech Leicester
 Executive Park, Avalon Way, Anstey,
 Leicester, United Kingdom, LE7 7GR
 Tel: +44 (0)11 6234 8000
 www.tetratechurope.com



Client
Bassetlaw District Council

Project Name
Ordsall, Retford Proposed Residential Development

Sheet Title
**JUNCTION 6
 A620 Babworth Road / B6420/Straight Mile /
 Sutton Lane**

TTE Project Number	Drawn By	Date	Checked By	Date	Approved By	Date	Scale @ A3	Suitability
B023665	SJR	AUG 21	BM	AUG 21	RH	AUG 21	1:500	S3
Client Project Number	Originator	Volume/System	Level/Location	Type/Code	Rate	Number	Revision	
B023665	- TTE	- 00	- XX	- SK	- O	- 0001	P02	

N:\Projects\B023665 - Ordsall, Retford\07 - AutoCAD & GIS\01 - DWGs\B023665-SK0001-SK0002_Junction 6 7 9 & Junction 14 Rev P02.dwg

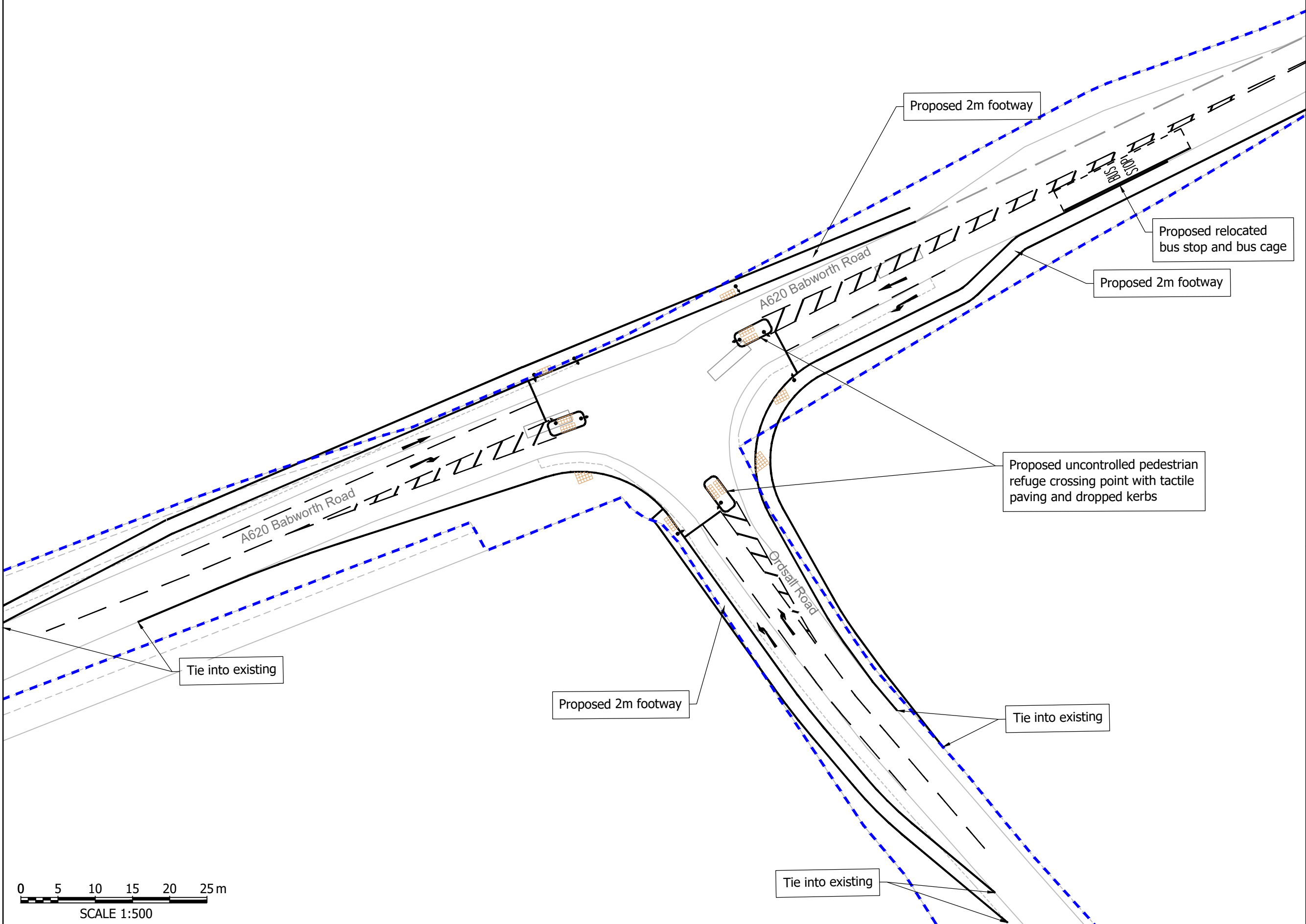

- Notes:**
- General**
1. Do not scale from drawing.
 2. All dimensions are in metres, unless stated otherwise.
 3. This drawing is to be read & printed in colour.
 4. This drawing is for illustrative purposes only.

- Disclaimer**
1. The information contained in this drawing is based on a combination of OS and data provided by others and Tetra Tech shall not be liable for any inaccuracies or deficiencies.

- Key**
- NEW KERB LINE
 - - - ADOPTED HIGHWAY AREA

PRELIMINARY ISSUE

Rev	Description	Date	By	App
P02	AMENDED TO ADDRESS NCC COMMENTS	07.02.2022	NJ	BG
P01	PRELIMINARY FIRST ISSUE	18.08.2021	SJR	BM

Issuing Office
Tetra Tech Leicester
 Executive Park, Avalon Way, Anstey,
 Leicester, United Kingdom, LE7 7GR
 Tel: +44 (0)11 6234 8000
 www.tetratech.europa.com



Client
 Bassetlaw District Council

Project Name
 Ordsall, Retford Proposed Residential Development

Sheet Title
JUNCTION 7
 MINI ROUNDABOUT A620 Babworth / Ordsall Road

TTE Project Number	Drawn By	Date	Checked By	Date	Approved By	Date	Scale @ A3	Stability
B023665	SJR	AUG 21	BM	AUG 21	RH	AUG 21	1:500	S3

Client Project Number	Originator	Volume/System Level/Location	Type/Code	Role	Number	Revision
B023665	TTE	- 00 - XX	- SK - O	- 0003	P02	

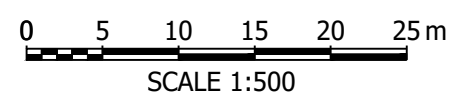

U:\Projects\B023665 - Ordsall, Retford\07 - AutoCAD & GIS\01 - DWGs\B023665-SK0001-SK0002_Junction 6 7 9 & Junction 14.dwg

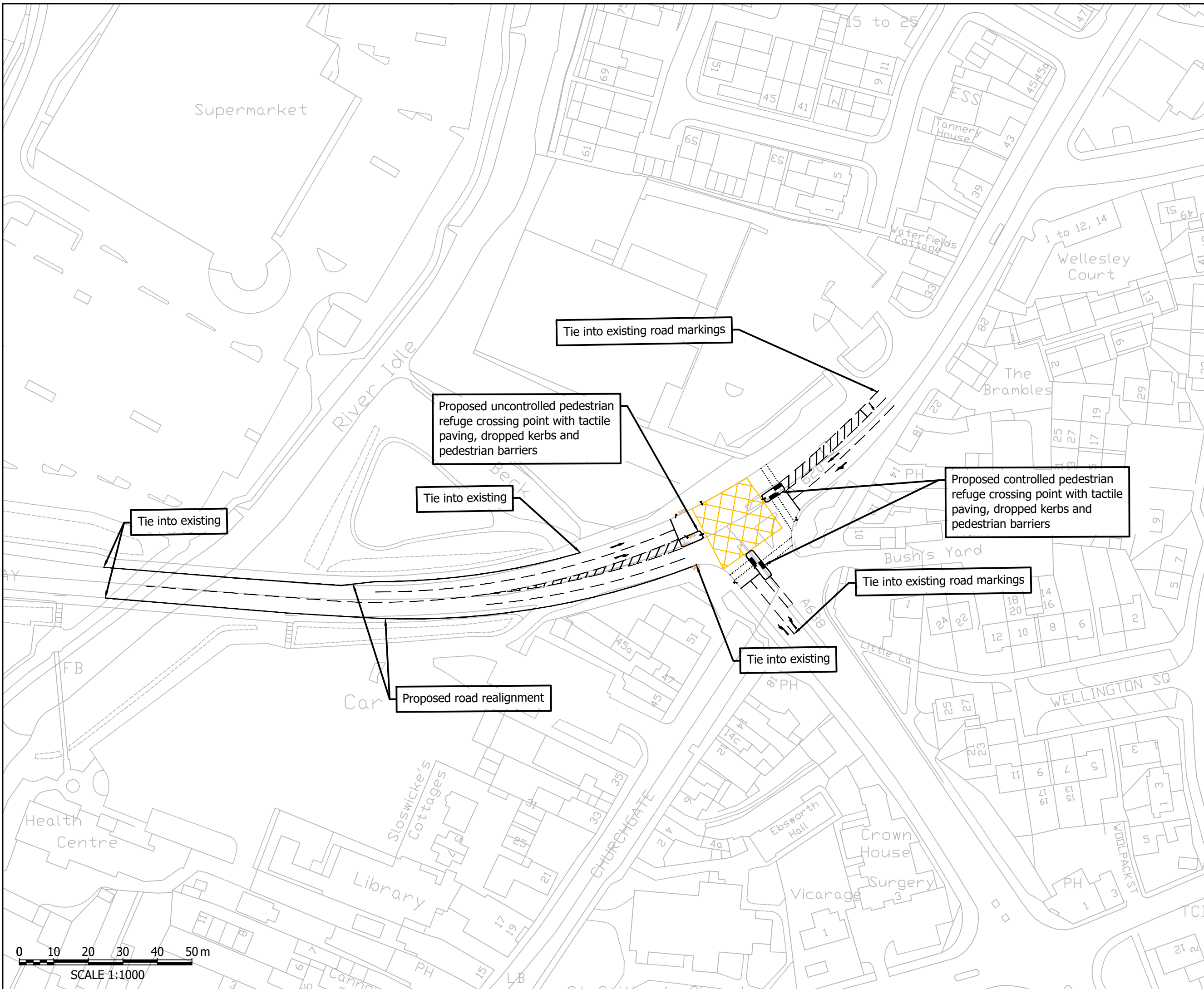

- Notes:**
- General**
1. Do not scale from drawing.
 2. All dimensions are in metres, unless stated otherwise.
 3. This drawing is to be read & printed in colour.
 4. This drawing is for illustrative purposes only.

- Disclaimer**
1. The information contained in this drawing is based on a combination of OS and data provided by others and Tetra Tech shall not be liable for any inaccuracies or deficiencies.

PRELIMINARY ISSUE

Rev	Description	Date	By	App
P01	PRELIMINARY FIRST ISSUE	18.08.2021	SJR	BM

Issuing Office
Tetra Tech Leicester
 Executive Park, Avalon Way, Anstey,
 Leicester, United Kingdom, LE7 7GR
 Tel: +44 (0)11 6234 8000
 www.tetratechleurope.com



Client
 Bassetlaw District Council

Project Name
 Ordsall, Retford Proposed Residential Development

Sheet Title
JUNCTION 9
 A638 Amcott Road / Moorgate/Arlington Way

TTE Project Number	Drawn By	Date	Checked By	Date	Approved By	Date	Scale	Stability
B023665	SJR	AUG 21	BM	AUG 21	RH	AUG 21	1:1000	S3
Client Project Number	Originator	Volume/System Level/Location	Type/Code	Role	Number	Revision		
B023665	TTE	00 - XX - SK - O - 0004			P01			

N:\Projects\B023665 - Ordsall, Retford\07 - AutoCAD & GIS\01 - DWGs\B023665-SK0001-SK0002-Junction 6 7 9 & Junction 14 Rev P02.dwg

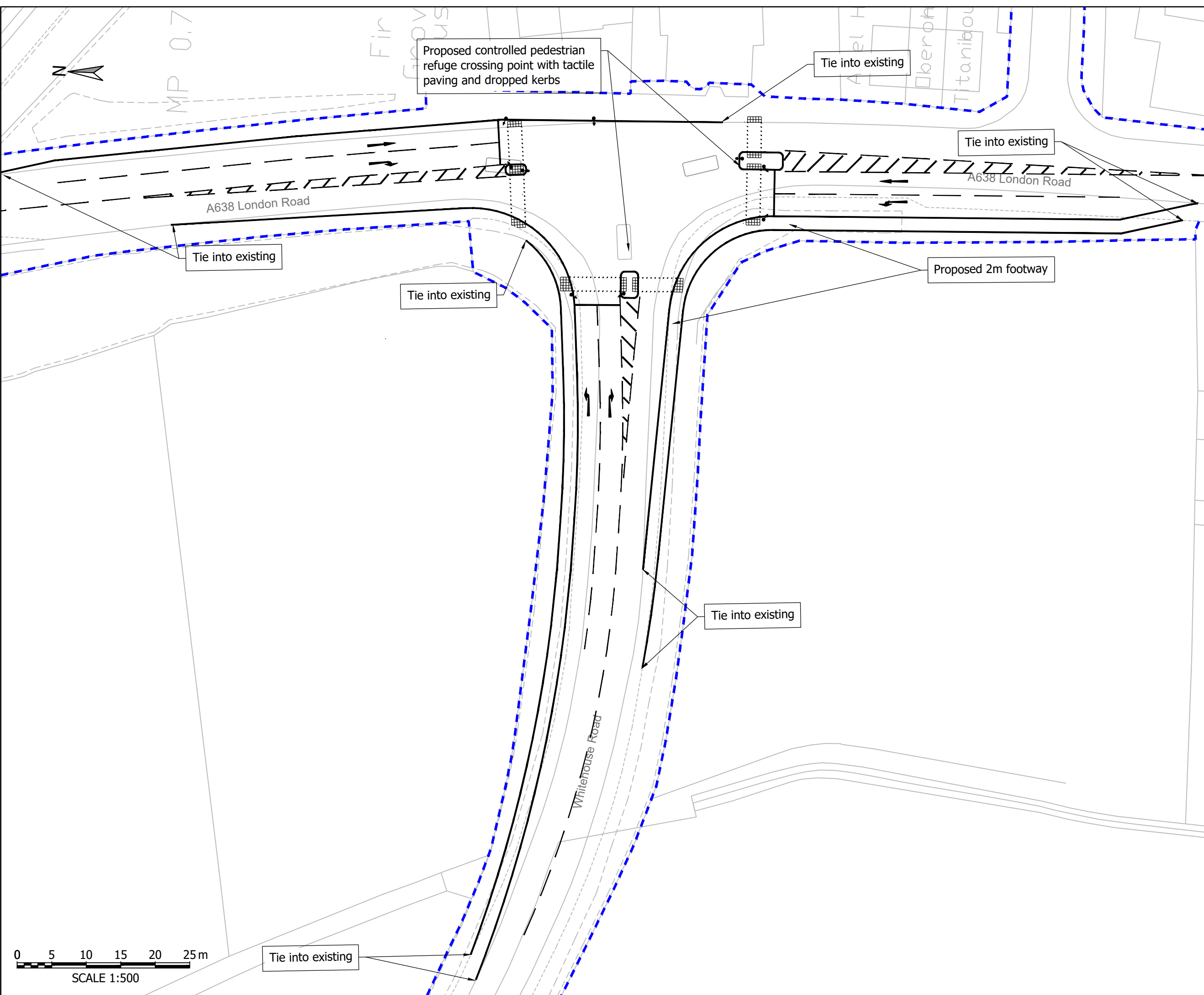

- Notes:**
- General**
1. Do not scale from drawing.
 2. All dimensions are in metres, unless stated otherwise.
 3. This drawing is to be read & printed in colour.
 4. This drawing is for illustrative purposes only.

Disclaimer

1. The information contained in this drawing is based on a combination of OS and data provided by others and Tetra Tech shall not be liable for any inaccuracies or deficiencies.

- Key**
- NEW KERB LINE
 - - - ADOPTED HIGHWAY AREA

PRELIMINARY ISSUE

Rev	Description	Date	Drawn	Appr
P02	AMENDED TO ADDRESS NCC COMMENTS	07.02.2022	NJ	BG
P01	PRELIMINARY FIRST ISSUE	18.08.2021	SJR	BM

Issuing Office
Tetra Tech Leicester
 Executive Park, Avalon Way, Anstey, Leicester, United Kingdom, LE7 7GR
 Tel: +44 (0)11 6234 8000
 www.tetrateteurope.com



Client
Bassetlaw District Council

Project Name
Ordsall, Retford Proposed Residential Development

Sheet Title
**JUNCTION 14
 MINI ROUNDABOUT A638 London Road /
 Whitehouses Road**

TTE Project Number	Drawn By	Date	Checked By	Date	Approved By	Date	Scale @ A3	Suitability
B023665	SJR	AUG 21	BM	AUG 21	RH	AUG 21	1:500	S3
Client Project Number	Originator	Volume/System	Level/Location	Type/Code	Rate	Number	Revision	
B023665	TTE	- 00	- XX	- SK	- O	- 0002	P01	

Retford TA Update - Summary of Junction Mitigation

Junctions Assessed in the TA															
Ref	Description	Junction Type	Location	Junction Performance with Development Traffic	Likely Mitigation Strategy	Total Cost	Indicative Costs (£m)								
							Cost Split Across Local Plan Allocation Sites								
							Ordsall South	Trinity Farm	Minercroft	Station Street	St Michaels	Fairygrove	Elizabethan	Peaks Hill Farm	Apleyhead
J1A	A1 / B6079 Retford Road	Simple Priority T-Junction	Ranby	Within capacity	-	£0									
J1B	A1 / A620 Retford Road	Simple Priority T-Junction	Ranby	Within capacity	-	£0									
J2A	A1 / B6420 Mansfield Road / A614 Blyth Road / A57	Priority Roundabout	Apleyhead	Over capacity	change to lane allocation and minor widening	£0.54	£0.10	£0.02	£0.00	£0.00	£0.00	£0.00	£0.02	£0.41	
J2B	Apleyhead Interchange (A57/Blyth Road / A1)	Priority Roundabout	Apleyhead	Within capacity	-	£0									
J3	Elkesley Bridge Road / A1 Worksop Road	Priority Roundabout	Elkesley	Within capacity	-	£0									
J3B	Jockey Lane / Eskil Way	Priority Roundabout	Elkesley	Within capacity	-	£0									
J4A	A1 / B6387 Dover Bottom (North)	Simple Priority T-Junction	Gamston	No Impact	-	£0									
J4B	A1 / B6387 Dover Bottom (South)	Simple Priority T-Junction	Gamston	No Impact	-	£0									
J5A	Markham Moor Interchange (A638 / A57 Cliff gate / A57 / A1)	Priority Roundabout	Markham Moor	Within capacity	-	£0									
J5B	A1 Markham Moor (A1 / Great N Road / Main Street / A57)	Priority Roundabout	Markham Moor	Within capacity	-	£0									
J6	A620 Babworth Road / B6420 Mansfield Road / A620 Straight Mile / Sutton Lane	Staggered Crossroads	Babworth	Over capacity	Replace with signal controlled staggered junction	£2.15	£1.43	£0.10	£0.00	£0.00	£0.01	£0.03	£0.02	£0.00	£0.56
J7	A620 Babworth Road / Ordsall Road	Mini-Roundabout	Retford	Over capacity	Replace mini-roundabout with signal control	£1.08	£0.76	£0.09	£0.00	£0.00	£0.01	£0.01	£0.02	£0.00	£0.19
J8	A620 Amcott Way / Bridlegate / A620 Hospital Road / A638 North Road / Hallcroft Road	Priority Roundabout	Retford	Over capacity	Very limited scope for physical improvements - address through demand management measures	£0.43	£0.14	£0.13	£0.00	£0.00	£0.01	£0.00	£0.02	£0.04	£0.08
J9	A620 Amcott Way / A620 Moorgate / A638 Arlington Way	Signals	Retford	Over capacity	Upgraded signal controlled scheme	£1.08	£0.33	£0.40	£0.00	£0.00	£0.00	£0.06	£0.00	£0.29	
J10	A638 Arlington Way / Spital Hill / Chapelgate	Signals	Retford	Within capacity	-	£0									
J11	A638 Arlington Way / Grove Street	Signals	Retford	Over capacity	Very limited scope for physical improvements - address through demand management measures	£0.43	£0.07	£0.17	£0.00	£0.00	£0.01	£0.03	£0.03	£0.12	£0.00
J12	A638 Arlington Way / A638 London Road / Carolgate	Signals	Retford	Over capacity	Very limited scope for physical improvements - address through demand management measures	£0.43	£0.22	£0.07	£0.00	£0.00	£0.01	£0.01	£0.02	£0.05	£0.05
J13	Ollerton Road / W Hill Road	Priority T-Junction	Retford	Within capacity	-	£0									
J14	London Road / Whitehouses Road	Mini-Roundabout	White Houses	Over capacity	Replace mini-roundabout with signal control	£1.08	£0.88	£0.09	£0.00	£0.00	£0.01	£0.07	£0.02	£0.00	£0.00
J15	London Road / Whinney Moor Lane / Bracken Lane	Priority Crossroads	Retford	Over capacity	Replace priority crossroads with signal control	£1.08	£0.77	£0.21	£0.01	£0.00	£0.02	£0.04	£0.04	£0.00	£0.00
J16	All Hallows Street / High Street / Goosemoor Lane	Simple Priority T-Junction	Ordsall	Within capacity	-	£0									
J17	Proposed site access	Priority Roundabout	Ordsall	Within capacity	-	£0									
J18	Ollerton Road / Brick Yard Road	Simple Priority T-Junction	Eaton	Within capacity	-	£0									
J19	A638 / Main Road	Simple Priority T-Junction	Eaton	Within capacity	-	£0									
J20	A638 / B6387 Rectory Lane	Ghost-Island Priority T-Junction	Gamston	Within capacity	-	£0									
Total (£m)						£8.29	£4.70	£1.27	£0.02	£0.00	£0.08	£0.25	£0.18	£0.22	£1.57